

PRESTO®

Pressure Cookers

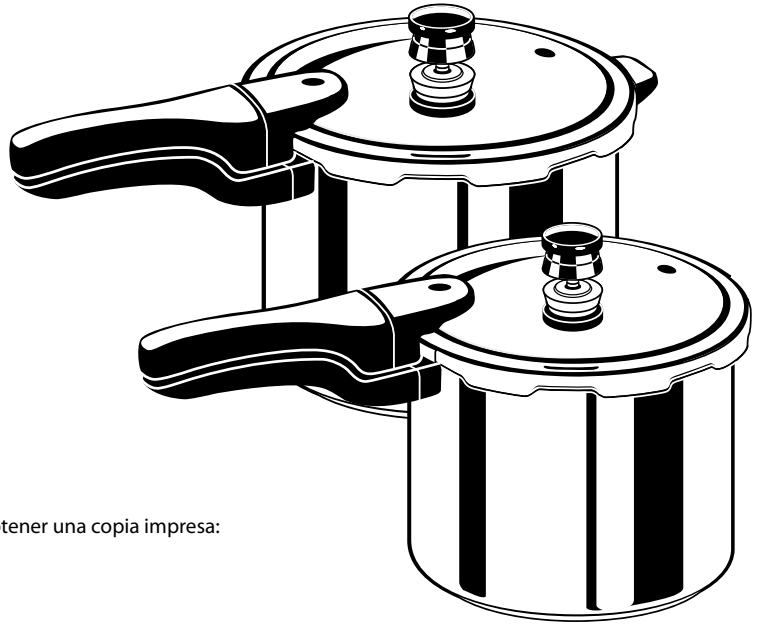

Stock Numbers:

- 01241 (4 quart aluminum)
- 01264 (6 quart aluminum)
- 01282 (8 quart aluminum)
- 01341 (4 quart stainless steel)
- 01362 (6 quart stainless steel)

The stock number is the first five digits of the model number.

Estas instrucciones también están disponibles en español. Para obtener una copia impresa:

- Descargue en formato PDF en www.GoPresto.com/espanol.
- Envíe un correo electrónico a contact@GoPresto.com.
- Llame al 1-800-877-0441, oprima 2 y deje un mensaje.



Instructions and Recipes

Visit us on the web at www.GoPresto.com
©2021 National Presto Industries, Inc.
Form 72-856C

This is a  Listed appliance. The following Important Safeguards are recommended by most portable appliance manufacturers.

IMPORTANT SAFEGUARDS

To reduce the risk of personal injury or property damage, basic safety precautions should always be followed, including the following:

1. Read all instructions.
2. Be sure that handles are assembled and fastened properly before using this appliance; see pages 2 and 3. Cracked, broken, or charred handles should be replaced.
3. Always check the vent pipe before use. Hold cover up to light and look through vent pipe to be certain it is clear.
4. Always check the air vent/cover lock to be sure it moves freely before use.
5. Do not fill pressure cooker over $\frac{2}{3}$ full. When cooking foods that foam, froth, or expand, such as rice, grains, dry beans, peas, and lentils, or foods that are mostly liquid, such as soup, never fill the cooker over $\frac{1}{2}$ full. Overfilling may cause a risk of blocking the vent pipe and developing excess pressure. See food preparation instructions.
6. Do not pressure cook applesauce, cranberries, rhubarb, cereals, pasta, split peas, and dried bean soup mixes. These foods tend to foam, froth, and sputter and may block the vent pipe, overpressure plug, and air vent/cover lock.
7. This appliance cooks under pressure. **WARNING!** Improper use may result in scalding injury. Make certain pressure cooker is properly closed before operating; cover handle must be directly above the body handle. See “How to Use” instructions.
8. Do not place the pressure cooker or attempt to pressure cook in a heated oven.
9. Extreme caution must be used when moving a pressure cooker containing hot liquids. Do not touch hot surfaces. Use handles or knobs.
10. Do not open pressure cooker until the unit has cooled and all internal pressure has been released, air vent/cover lock has dropped, and no steam escapes when the pressure regulator is removed. If the handles are difficult to push apart, this indicates that the cooker is still pressurized; do not force it open. Any pressure in the cooker can be hazardous. See “How to Use” instructions.
11. To ensure safe operation and satisfactory performance, replace the overpressure plug every time you replace the sealing ring or sooner if it becomes hard, deformed, cracked, worn, or pitted. It is recommended that the sealing ring and overpressure plug be replaced at least every two years. Use only genuine Presto® accessories and replacement parts.
12. Close supervision is necessary when the pressure cooker is used near children. It is not recommended that children use the pressure cooker.

13. When normal operating pressure is reached, the pressure regulator will begin to rock. Gradually lower the heat to maintain a slow, steady rocking motion. If the pressure regulator is allowed to rock vigorously, excess steam will escape, liquid will be evaporated, food may scorch, and the cooker may be damaged.
14. **WARNING!** Do not use pressure cooker on an outdoor LP gas burner or gas range over 12,000 BTUs. Doing so may result in damage to the pressure cooker and/or property damage and personal injury.
15. Do not use this pressure cooker for other than intended use.
16. Do not use this pressure cooker for pressure frying with oil.

SAVE THESE INSTRUCTIONS

THIS APPLIANCE IS FOR HOUSEHOLD USE ONLY.

Table of Contents

Important Safeguards	1	Fish and Seafood	11
Introduction	5	Poultry	13
Handle Installation	3	Meats	15
Getting Acquainted	3	Vegetables	19
How to Use	3	Dry Beans, Peas, and Lentils	21
Important Safety Information	5	Grains	22
Cleaning	6	Desserts	23
Care and Maintenance	7	Recipe Index	25
Helpful Hints	7	Consumer Service Information	26
Questions and Answers	8	Warranty	27
Soups and Stocks	9		

Introduction

Welcome to the world of pressure cooking. With your new Presto® pressure cooker, you'll discover how fast and easy it is to prepare a wide variety of delicious foods, especially foods that emphasize good health and nutrition along with good taste.

The pressure cooker is perfect for the way we live and eat today. It's ideal for preparing many of the lighter foods that help keep us healthy and fit. It preserves flavors and nutrients, tenderizes meat and, best of all, it cooks foods three to ten times faster than ordinary cooking methods. And, it's even possible to cook several foods in the pressure cooker at the same time without the flavors intermingling.

We have included recipes for some traditional family favorites that are especially well suited to the many advantages of pressure cooking. To help get started with your new pressure cooker, be sure to read the "Getting Acquainted" section on page 3.

Handle Installation

Tools Required: Phillips screwdriver

Note: The pressure cooker handles can be found inside the pressure cooker body in individual plastic bags.

Attach Helper Handle to Cooker Body (Does not apply to 4-quart pressure cooker, stock number 01241)

1. Place pressure cooker body upside down on table or counter (Fig. A).
2. Locate bag containing short helper handle. Take out handle and remove tape on handle which is holding screw in place. Remove screw from handle and set aside.
3. Position helper handle, with indented side facing up, onto threaded post under fill lines (Fig. A). Insert screw into helper handle hole and, using a Phillips screwdriver, fasten handle securely to post.

When properly installed, handle should appear level with table or counter (Fig. A). **NOTICE:** Overtightening can result in stripping of screws or cracking of handles.

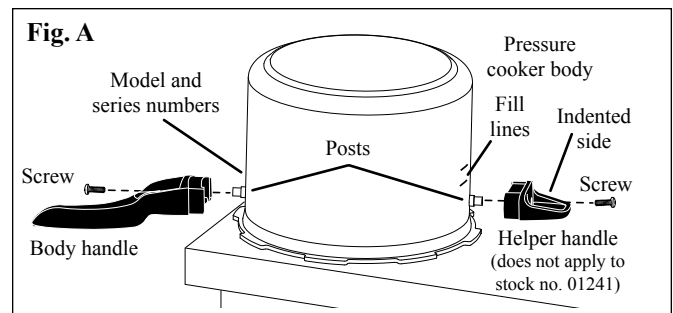

Attach Body Handle to Cooker Body

1. Locate bag containing long body handle. This is the handle that has one screw hole. Take out handle and remove tape which is holding screw in place. Remove screw from handle and set aside.
2. For easier handle installation, position cooker body so threaded post extends over edge of counter slightly.
3. Position long body handle, with ▲ facing down, onto threaded post which is under the model and series numbers (Fig. A, page 2).
4. Insert screw into handle hole and use a Phillips screwdriver to fasten handle securely to post. **NOTICE:** Overtightening can result in the stripping of screws or the cracking of handles.

Attach Cover Handle to Cooker Cover

1. Locate bag containing cover handle. This handle has three holes, two of which contain screws. Take out handle and remove tape which is holding the screws in place. Remove screws from handle and set aside.
2. Place pressure cooker cover upside down on table or counter (Fig. B) so vent pipe bottom faces you.
3. Fit cover handle, with indented side facing up, onto cover handle mount so air vent/cover lock stem fits through center hole of cover handle (Fig. B).
4. Insert screws into holes on both sides of center hole and use a Phillips screwdriver to fasten cover handle securely to cover handle mount.

NOTICE: Overtightening can result in the stripping of screws or the cracking of handles.

Important: After placing cover on cooker body, check positioning of handles. Follow step 4 on page 4. When properly installed, body handle and cover handle will line up with each other without interference.

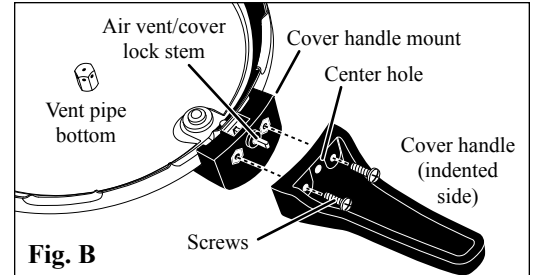

Fig. B

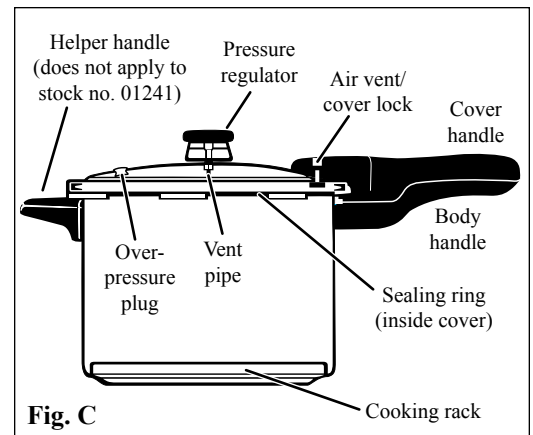

Fig. C

Getting Acquainted

Your pressure cooker is like a saucepan with a very special cover that locks in place. Air is automatically exhausted and steam is sealed inside creating pressure within the unit. Under pressure, internal temperatures in the cooker are raised above the normal boiling point of water.

At 15 pounds of pressure, a temperature of 250°F (or 121°C) is reached inside the pressure cooker. These higher temperatures speed cooking, and the moist steam atmosphere tenderizes meats naturally.

It is important to become familiar with the various parts of the pressure cooker (Fig. C) and to read the “How to Use” section below before using the unit for the first time.

Before the first use, remove the sealing ring (Fig. D) by simply pulling it out of the inside rim of the cover. Wash sealing ring, cover, body, and cooking rack in hot, soapy water to remove any packaging material and white manufacturing lubricant.

Rinse all parts with warm water and dry. Then, replace the sealing ring, being careful to fit it under the stop tabs and the lock pin which are located on the inside rim of the cover (Fig. D).

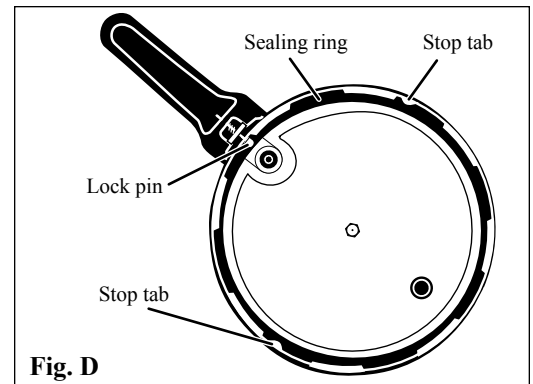

Fig. D

How to Use

To assure the very best results every time, carefully follow these step-by-step instructions for pressure cooking. You may find it helpful to refer to Fig. C.

1. Prepare ingredients according to the directions in the pressure cooking recipe you have selected.

Recipes in this book were developed for use in a 4-quart pressure cooker. If you have a 6-quart pressure cooker, you may increase the ingredients by ½. If you have an 8-quart pressure cooker, you may double the ingredients. Be sure not to overfill the pressure cooker; see page 5 for guidance on filling.

Pour liquid into the cooker body, as specified in the recipe or timetable. This liquid is usually water. However, some recipes will call for other liquids, such as broth, juice, or wine.

2. Place the cooking rack into the cooker, if called for in the recipe; see “Helpful Hints” on page 7 for guidance on when to use.

- Important:** Look through the vent pipe to make certain that it is clear (Fig. E) before placing cover on cooker body. See safety information on page 15. If blocked, clean as described in step 2, page 6.

Holding the body handle with your left hand and the cover handle with your right hand, align the **V** (or **▼**) mark on the cover with the **▲** mark on the body handle and place the cover on the cooker body (Fig. F). *Aluminum cookers have a **V** mark on the cover and stainless steel cookers have a **▼** mark on the cover.*

- After placing the cover on the cooker body, place one hand on the center of the cover and apply a slight downward pressure. Place the thumb of your other hand on the side of the body handle and wrap your fingers around the cover handle (Fig. G).

Then rotate the cover clockwise as far as it will rotate without being forced. **The pressure cooker is completely closed when the cover handle is above or just slightly to the left of the body handle (Fig. H).**

- Place the pressure regulator on the vent pipe (Fig. I). The pressure regulator will fit loosely on the vent pipe. It will not touch the top of the pressure cooker cover.

- Position the pressure cooker on your stove. If your stove is electric coil or smooth top, use the element that most closely matches the diameter of the cooker bottom. Using a high heat setting on your stove, begin heating the pressure cooker.

Note: The air vent/cover lock may move up and down a few times when cooking first begins as it automatically exhausts air from the pressure cooker. Steam will be noticeable. This is normal. When pressure begins to build, it slides up, locking the cover on. Once the cooker has sealed, the air vent/cover lock will remain in its raised position until pressure is released (Fig. J).

- Once the pressure regulator begins to rock, cooking time begins. Gradually lower the heat as necessary to maintain a slow, steady rocking motion and cook for the length of time indicated in the recipe or timetable. To watch a video of a regulator maintaining a slow, steady rocking motion, visit www.GoPresto.com/ppc/rocking.

- During the first several minutes after adjusting the heat, remain by the pressure cooker to make sure the heat setting is adequate to keep the pressure regulator rocking at a slow, steady rate. If the heat has been lowered too much, the pressure regulator may stop rocking and it will be necessary to increase the heat.

If the heat is too high and the pressure regulator rocks vigorously, excess steam will escape and too much liquid will evaporate. The cooker may go dry and food may scorch. If this situation happens, the pressure regulator will stop rocking. Remove the pressure cooker from the heat source to prevent overheating and potential damage.

- When cooking time is complete, turn off burner. If using an electric stove, remove pressure cooker from burner.

NOTICE: Lift pressure cooker to remove it from burner. Sliding cookware can leave scratches on stovetops.

- Reduce pressure according to the recipe or timetable instructions.

If the instructions say “Let the pressure drop of its own accord,” set the pressure cooker aside to cool until pressure is completely reduced.

If the instructions state, “Cool cooker at once,” cool the pressure cooker under a running water faucet (Fig. K) or pour cold water over it, or place it in a pan of cold water (Fig. L) until pressure is completely reduced.

NOTICE: Do not set hot cooker in a molded sink as it could damage the sink.

Pressure is completely reduced when the air vent/cover lock has dropped. If the air vent/cover lock remains in its raised position, there is still pressure inside the pressure cooker. Continue to cool until the air vent/cover lock drops.

- After pressure has been completely reduced, i.e., the air vent/cover lock has dropped, remove the pressure regulator. **Always remove the pressure regulator before opening the cover.**

- To open the cover, turn it counterclockwise until the **V** (or **▼**) mark on the cover aligns with the **s** mark on the body handle. Then, lift the cover toward you to keep any steam away from you.

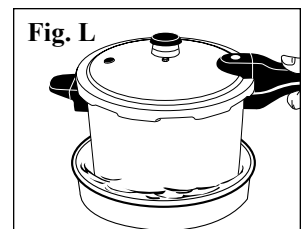
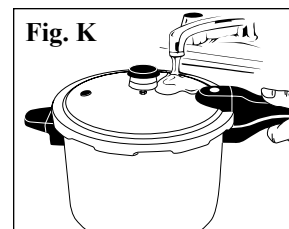
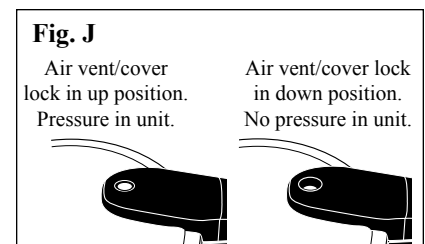
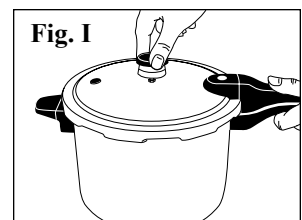
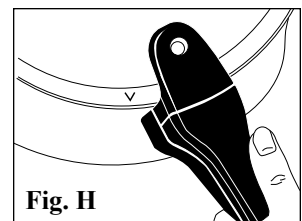
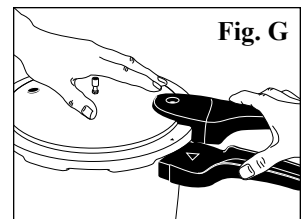
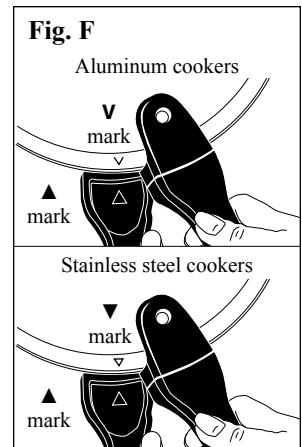
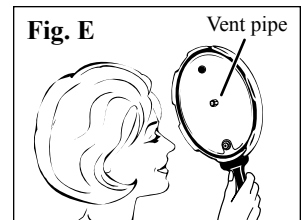

If the cover turns hard, there still may be some pressure in the unit. **Do not force the cover off.** Continue to cool the pressure cooker until steam no longer is escaping from the vent pipe, the air vent/cover lock has dropped, and the cover turns easily.

13. Food is ready to serve.
14. Clean your pressure cooker according to the instructions on page 6.

Important Safety Information

Cooking under pressure enables you to prepare food both quickly and deliciously. If used properly, your pressure cooker is one of the safest appliances in your kitchen. To ensure safe operation, make sure you always observe the following simple rules whenever you use the pressure cooker:

1. **Never overfill the pressure cooker.** The pressure regulator is designed to maintain cooking pressure at a safe level. It relieves excess pressure through the vent pipe as it rocks back and forth. Many foods tend to expand when cooked. If the cooker is overfilled, expansion of food may cause the vent pipe to become blocked or clogged. If the vent pipe becomes blocked, it cannot relieve excess pressure.

Do not fill the cooker above the $\frac{2}{3}$ fill line when cooking most foods. When cooking foods that foam, froth, or expand, such as rice, grains, dry beans, peas, and lentils, or foods that are mostly liquid, such as soups, never fill the cooker above the $\frac{1}{2}$ fill line.

For your convenience, both the $\frac{2}{3}$ and $\frac{1}{2}$ full levels are marked by indentations on the side of the pressure cooker body (Fig. M). The upper marking indicates the $\frac{2}{3}$ full level and the lower the $\frac{1}{2}$ full level. In addition, in each section of the recipes you will find instructions on the maximum fill level for each type of food.

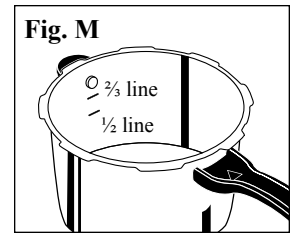

Reminder: When cooking any food, do not let any portion extend above the maximum fill mark. When cooking rice, grains, dry beans, peas, lentils, soups, and stews, the cooker should never be more than $\frac{1}{2}$ full.

2. **Never pressure cook applesauce, cranberries, rhubarb, cereals, pasta, split peas, and dried soup mixes.** These foods expand so much as a result of foaming and frothing that they should never be cooked under pressure.
3. **Always follow special procedures found in the instruction book when pressure cooking rice, grains, dry beans, peas, and lentils.** During cooking, dry beans, peas, and lentils tend to froth and foam which could cause the vent pipe to become blocked. Therefore, dry beans, peas, and lentils need to be prepared and cooked according to instructions beginning on page 21. Using this method will keep foam at safe levels during cooking.

Like dry beans, peas, and lentils, rice and grains tend to froth and foam during cooking; therefore, to contain foaming and frothing during the cooking period, rice and grains must be prepared in a bowl in the pressure cooker according to directions on page 22.

4. **Always add cooking liquid.** If an empty pressure cooker is left on a hot burner or if a cooker boils dry and is left on a heated burner, the cooker will overheat excessively, causing possible discoloration and/or damage to the cooker.
5. **Always look through the vent pipe before using the cooker to make sure it is clear.** If the vent pipe is blocked, it cannot function as it should and thus cannot relieve excess pressure. Pressure may then build to unsafe levels. To clean it, see page 6.
6. **Always fully close the pressure cooker.** Rotate the cover clockwise as far as it rotates without being forced. The cooker is fully closed when the cover handle is above or slightly to the left of the body handle (Fig. H, page 4).

Your pressure cooker has specially designed lugs on the cover and body which lock the cover in place when the cooker is fully closed. However, if the cooker is not fully closed, the lugs cannot lock the cover onto the body. It's possible that pressure could build inside the cooker and cause the cover to come off and result in bodily injury or property damage.

7. **Never open the cooker when it contains pressure.** The air vent/cover lock provides a visual indication of pressure inside the cooker. When it is up, there is pressure. When it is down, there is no pressure in the cooker and it can be opened.

If the pressure cooker is opened before all of the pressure is released, the contents of the cooker will erupt and could cause bodily injury or property damage.

8. **Replace the sealing ring if it becomes hard, deformed, cracked, worn, pitted, or soft and sticky.** The sealing ring provides a pressure tight seal between the cover and body. The sealing ring needs to be in good condition to function properly.

WARNING! Failure to replace the sealing ring when it is hard, deformed, cracked, worn, pitted, or soft and sticky could result in bodily injury or property damage. It is recommended that the sealing ring be replaced every two years.

9. **Replace the overpressure plug if it is hard, deformed, cracked, worn or pitted, or when replacing the sealing ring.** The overpressure plug is a secondary pressure relief valve which is designed to relieve excess pressure by releasing from the cooker cover in the event that the vent pipe becomes blocked.

The overpressure plug is made of rubber, and when new, is soft and pliable. Over time, depending on the frequency and type of use, rubber becomes hard and inflexible. When hard and inflexible, the overpressure plug loses its ability to act as a secondary pressure relief valve; replace it immediately. It is recommended that the overpressure plug be replaced every two years.

Should the overpressure plug ever be forced out of the cover due to excess pressure while cooking, it is important to call the Test Kitchen at 1-800-368-2194. **Do not attempt to use the released overpressure plug.**

Cleaning

1. All parts of your pressure cooker, including the sealing ring and pressure regulator, are fully immersible for easy cleaning. When washing the unit, the sealing ring should be removed to allow easy cleaning of the inside rim of the cover. The sealing ring should be washed in hot, soapy water after each use.
2. To be sure the vent pipe is clear, hold the cover up to the light and look through the vent pipe. Clean it with a small brush or pipe cleaner if it is blocked or partially blocked (Fig. N). Also clean the vent pipe nut as shown.
3. Occasionally remove the air vent/cover lock in the pressure cooker cover handle for cleaning. To remove the air vent/cover lock, place your finger over the hole in the cover handle (Fig. N) and remove the white rubber gasket from the air vent/cover lock on the underside of the cover (Fig. O).

Push the air vent/cover lock through the top of the cover and wash it and the gasket in hot, soapy water. The metal shaft of the air vent/cover lock may be cleaned with a nylon mesh pad. Clean the hole in the cover handle with a small brush.

After cleaning, reinsert the metal shaft of the air vent/cover lock from the top side of the cover down through the cover handle hole (Fig. P). Place a finger over the handle hole (to keep the cover lock from falling out) and turn the cover over. Wet the rubber gasket and push onto the end of the metal shaft until it snaps into the groove on the shaft.

4. The overpressure plug can also be removed for cleaning by pushing it out of its opening from the top of the cover. After cleaning, reinsert it by pushing the domed side of the plug, marked TOP, into the opening from the underside of the cover, until the bottom edge is fully and evenly seated against the underside of the cover (Fig. Q).

When the overpressure plug is properly installed, the word TOP will be visible on the overpressure plug when viewing the outside of the cover.

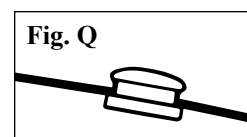
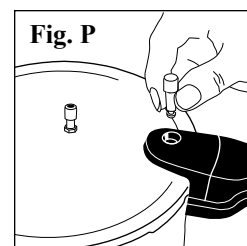
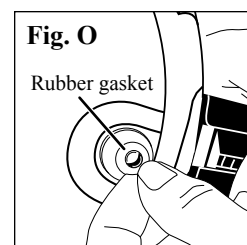
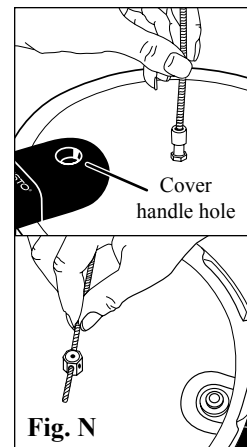

Special Cleaning Instructions for Aluminum Cookers

1. Iron and other minerals in water and foods may darken the inside of your aluminum cooker. This discoloration will not affect the food cooked in the unit. These stains can be removed by using a solution of water and cream of tartar. Use a tablespoon of cream of tartar for each quart of water and pour enough solution into the cooker to cover the discoloration (do not fill over $\frac{2}{3}$ full).

Close the cover securely, place the pressure regulator on the vent pipe, and heat until the pressure regulator rocks gently. Remove the cooker from the heat and allow it to stand for two to three hours. Remove the pressure regulator and discard the contents. Scour thoroughly with a soap impregnated steel wool pad; wash, rinse, and dry.

2. The outside surface of aluminum pressure cookers may be cleaned with a good silver polish, if necessary. Staining may result if the cooker is washed in the dishwasher. If food residue adheres to the pressure cooker body, clean with a nylon mesh pad, a fine steel wool pad, or a fine kitchen cleanser.

Special Cleaning Instructions for Stainless Steel Cookers

1. If food residue adheres to the pressure cooker body, clean with a stainless steel scouring pad, a nylon mesh pad, or a powdered cleanser without bleach, such as Bar Keepers Friend* cleanser and polish or Cameo* copper, brass & porcelain cleaner. Do not use steel wool or cleansers with chlorine bleach.

Your stainless steel pressure cooker may also be washed in a dishwasher. When washing in a dishwasher, you must first remove the sealing ring and overpressure plug from the cover as these parts must be hand washed.

2. To bring out its luster, the outside surface of your stainless steel pressure cooker can be cleaned occasionally with a silver polish or any other fine, non-abrasive polish. Take care not to overheat your stainless steel pressure cooker. Very high heat can cause varicolored stains, or heat tints, in stainless steel, which can usually be removed by using a non-abrasive powder cleanser.

* Bar Keepers Friend is a registered trademark of SerVaas Laboratories, Inc. Cameo is a registered trademark of Church & Dwight Co., Inc. Presto is not affiliated with these companies.

Care and Maintenance

1. When not in use, store your pressure cooker in a dry place with the cover inverted on the body. If the cover is locked on, unpleasant odors may form inside the unit and the sealing ring could be damaged.
2. As is the case of all cookware, avoid chopping or cutting food inside the cooker with a knife or other sharp utensil.
3. If the body or cover handles become loose, tighten them with a screwdriver. **NOTICE:** Overtightening can result in stripping of screws or cracking of handles.
4. Periodically check the vent pipe nut for looseness. Retighten, if necessary, using a 7/16" wrench.
5. Do not strike the rim of the pressure cooker with any cooking utensil because this could cause nicks in the rim which may allow steam to escape and prevent the pressure cooker from sealing.
6. The sealing ring, overpressure plug, and rubber gasket for the air vent/cover lock may shrink or become hard, deformed, cracked, worn, or pitted with normal use. Exposure to high heat, such as a warm burner or oventop, will cause these parts to deteriorate rapidly. When this happens, replace these parts. *Replace the sealing ring and overpressure plug at least every two years.*

Leakage between the cover and body is usually caused by shrinkage of the sealing ring after prolonged use. Replace the sealing ring. *Whenever you replace the sealing ring, replace the overpressure plug also.*

Leakage may also occur if the rim of the cooker body has been damaged; see #5 above.

7. Each time you clean or use your pressure cooker, check to be sure the bottom has not been damaged. Nicks and scratches may leave sharp edges that can damage ceramic stovetops or other smooth surfaces. **NOTICE:** Lift pressure cooker to remove it from burner. Sliding cookware could leave scratches on stovetops.
8. The formation of a small amount of moisture under the pressure regulator is normal when cooking first begins. It is the result of the temperature of the regulator being lower than the rest of the unit.

A small amount of steam or moisture may also be visible around the overpressure plug and air vent/cover lock as cooking begins. It should stop when pressure begins to build and the overpressure plug and air vent/cover lock seal. If leakage continues, clean or replace the overpressure plug and/or air vent/cover lock assembly. The pressure cooker will not seal if the gasket for the air vent/cover lock is cracked.

Do not operate your pressure cooker with continual leakage. If the preceding steps do not correct the problem, call the Consumer Service Department at 1-800-877-0441. If unable to resolve the problem, you may be asked to return the entire unit to the Presto Factory Service Department; see page 26.

9. If the pressure cooker becomes difficult to open or close, the sealing ring needs to be replaced. If for any reason the pressure cooker cannot be opened, contact the Presto Consumer Service Department in Eau Claire, WI at 1-800-877-0441.

Any maintenance required for this product, other than normal household care and cleaning, should be performed by the Presto Factory Service Department; see page 26.

Helpful Hints

- Your favorite recipes may be adjusted for cooking in the pressure cooker by following the general directions in this book for the particular type of food being cooked. Decrease the cooking time for your recipe by $\frac{2}{3}$ since pressure cooking is much faster than ordinary cooking methods. For example, if your ordinary cooking method requires 45 minutes, in the pressure cooker the cooking time will be 15 minutes.

Because there is very little evaporation, the amount of liquid used should be decreased. Use about $\frac{1}{2}$ cup more liquid than you'll desire in your finished dish. But, remember, there must always be water or some other liquid in the pressure cooker to produce the necessary steam.

- Many different cooking liquids can be used in a pressure cooker. Wine, beer, broth, fruit juices, and water all make excellent cooking liquids.
- Use the cooking rack when it is desirable to cook foods out of the cooking liquid. When foods are pressure cooked out of the liquid, flavors will not intermingle. Therefore, it is possible to cook several foods at once, as long as they have similar cooking times. If it is desirable to blend flavors, do not use the cooking rack.
- Beautiful desserts and side dishes may be prepared in the pressure cooker; use oven-safe custard cups, ramekins, or individual or small metal molds or forms. Fill molds $\frac{2}{3}$ full to allow for expansion of food, and fit them loosely into the pressure cooker on the cooking rack. Do not fill the pressure cooker over $\frac{2}{3}$ full.
- If a recipe says to cook 0 minutes, cook food only until the pressure regulator begins to rock. Then cool pressure cooker according to the recipe.

- The pressure cooker is usually cooled at once for delicate foods such as custards and fresh vegetables. For other foods, like meats, soups, and grains, let the pressure drop of its own accord.
- When pressure cooking at high altitudes, the cooking time needs to be increased 5% for every 1,000 feet above the first 2,000 feet. Following this rule, the times should be increased as follows:

3,000 ft. ... 5%	5,000 ft. ... 15%	7,000 ft. ... 25%
4,000 ft. ... 10%	6,000 ft. ... 20%	8,000 ft. ... 30%

Because pressure cooking times are increased at altitudes of 3,000 feet or above, an additional ½ cup cooking liquid is needed.

- If you have any questions on recipes or cooking times, call our Test Kitchen at 1-800-368-2194. You may also email us through our website at www.GoPresto.com/contact.
- Visit www.GoPresto.com for videos and additional recipes.

Questions and Answers

Occasionally the cover is hard to open or close. What causes this? What should I do?

In order for pressure to build inside your pressure cooker, the unit has a special cover which provides an airtight fit. Because of this, you may find that on occasion the cover may be difficult to open or close. The following suggestions will help if this happens:

If the cover seems hard to close, press the palm of your hand on the center of the cover while moving the cover handle to the closed position with your other hand (Fig. G, page 4).

If after browning meat or poultry the cover is difficult to close, it may be due to expansion of the pressure cooker body from heating. Remove the cover and allow the pressure cooker body to cool slightly and try again. Do not place the pressure cooker back on the burner until it is fully closed.

If necessary, to help make the cover easier to open and close, a very light coating of vegetable oil may be applied to the sealing ring and to the underside of the lugs on the pressure cooker body (Fig. R). Use a pastry brush, a piece of cloth, or your fingertips and be sure to wipe off any excess oil.

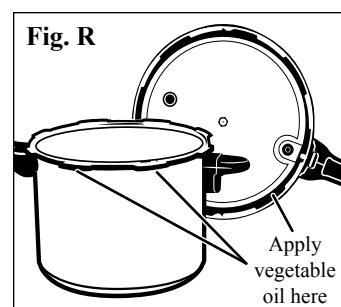

What can be done if the food prepared in the pressure cooker has more liquid than desired?

With the cover removed, simmer to evaporate the excess liquid. Next time you prepare the same recipe, use less liquid.

How does one prevent overcooking?

Remember to begin timing as soon as the pressure regulator begins to rock gently. It is very important to accurately time the cooking period. A Presto® kitchen timer is very helpful for this purpose. Also be sure to follow the recipe instructions for cooling the cooker.

What if the food is not completely done after the recommended cooking time?

Simply bring the cooker back up to pressure and cook the food a minute or two longer.

Can I use my pressure cooker on all types of ranges?

Presto® pressure cookers will work on gas, electric coil, and ceramic glass (smooth-top) ranges; see step 6 on page 4 for correct burner size. In addition, Presto® stainless steel pressure cookers will also work on induction ranges. Because aluminum pressure cookers are not magnetic, they will not work on induction ranges.

When cooking first begins, is it normal for steam to escape and moisture to form on the cover and between the handles?

It is normal for steam to escape and a slight amount of moisture leakage to form on the cover and between the handles when cooking first begins. If leakage continues, the cover handle may not be properly aligned with the body handle and, therefore, the cover lock cannot engage.

Is it normal for the air vent/cover lock to rise up partially and drop back down when cooking first begins?

Yes, it is normal for the air vent/cover lock to move up and down slightly when cooking first begins. Do not be concerned. The air vent/cover lock will remain in the up position once the cooker has sealed. However, if the air vent/cover lock continues to move up and down or rises partially, tap it lightly with the tip of a knife. If it does not rise once you have tapped it, the following may be occurring:

1. The burner is not hot enough.
2. The cooker is not fully closed; see page 4.
3. There is insufficient liquid to form steam.
4. The gasket for the air vent/cover lock needs to be replaced; see page 6.

Soups and Stocks

The pressure cooker is perfect for preparing delicious soups and stocks in minutes instead of the hours taken by ordinary methods. Included are a few favorite recipes. If you have a favorite recipe of your own, try it in the pressure cooker using one of the recipes in this book as your guide. If adding dry beans and peas, they must first be soaked according to directions on page 21.

CAUTION! Do not pressure cook soups containing barley, rice, pasta, grains, split peas, and dried soup mixes because they have a tendency to foam, froth, and sputter and could block the vent pipe. These foods should be added to the soup AFTER pressure cooking.

FOR SOUPS AND STOCKS, DO NOT FILL PRESSURE COOKER OVER ½ FULL!

**OPERATING THE COOKER WITHOUT COOKING LIQUID OR
ALLOWING THE COOKER TO BOIL DRY WILL DAMAGE THE COOKER.**

Brown Beef Soup

1½ pounds lean beef, cut into 1-inch cubes
4 cups water
½ cup chopped onion
½ cup sliced carrots
¼ cup chopped celery

1 bay leaf
1 teaspoon parsley flakes
1 teaspoon salt
¼ teaspoon black pepper

Add beef, water, onion, carrots, celery, bay leaf, parsley flakes, salt, and pepper to cooker. Close cover securely. Place pressure regulator on vent pipe and cook 12 minutes with pressure regulator rocking slowly. Let pressure drop of its own accord.

4 servings

Delicious Soups from Brown Beef Soup

Brown Beef Soup Stock

Strain Brown Beef Soup to make stock.

Beef Tomato Soup

Add 2 cups tomato juice and 1 cup cooked rice to Brown Beef Soup. Heat through.

8 servings

Onion Soup

Heat 2 tablespoons vegetable oil in cooker over medium heat. Add 1½ cups thinly sliced onions and sauté until tender. Stir onions into 6 cups Brown Beef Soup Stock in cooker. Season with ¼ teaspoon black pepper. Close cover securely. Place pressure regulator on vent pipe and cook 2 minutes with pressure regulator rocking slowly. Let pressure drop of its own accord. Ladle into soup bowls. Top with Parmesan cheese. If desired, garnish with croutons or toasted French bread.

6 servings

Chicken Soup

1½ pounds chicken, cut into serving pieces
4 cups water
½ cup sliced carrots
½ cup chopped onion

¼ cup chopped celery
1 teaspoon salt
¼ teaspoon black pepper

Add chicken, water, carrots, onion, celery, salt, and pepper to cooker. Close cover securely. Place pressure regulator on vent pipe and cook 12 minutes with pressure regulator rocking slowly. Let pressure drop of its own accord. Remove pieces of chicken from cooker and let cool. Remove meat from bones and return meat to cooker. Heat through.

4 servings

Delicious Soups from Chicken Soup

Chicken Soup Stock

Strain Chicken Soup to make stock.

Chicken Noodle Soup

Bring soup to a boil. Add fine noodles and simmer, uncovered, 10 to 15 minutes. Salt and pepper to taste.

6 servings

Chicken Dumpling Soup

Mix 1 egg, ½ cup milk, and ½ teaspoon salt in a bowl. Stir in 1¼ cups flour. Drop mixture from teaspoon into bubbling Chicken Soup in cooker. Simmer uncovered 6 minutes.

6 servings

Chicken Rice Soup

Add 1 cup cooked rice to Chicken Soup. Heat through. Salt and pepper to taste.

6 servings

Black Bean Soup

- | | |
|---|---|
| 2 cups dry black beans | 4 cups chicken stock or broth |
| 1 tablespoon olive or vegetable oil | 2 cups sliced carrots, $\frac{3}{4}$ inch thick |
| 1 cup chopped onion | 1 tablespoon packed brown sugar |
| 3 cloves garlic, minced | 2 teaspoons white wine vinegar |
| 1-2 jalapeño chiles, seeded, deveined, minced | •••••••• |
| 1 tablespoon chili powder | 1 cup loosely packed fresh cilantro, chopped |
| 1½ teaspoons dried oregano | Salt |
| ½ teaspoon allspice | |

Soak beans according to instructions on page 21. Heat oil in cooker over medium heat. Add onion, garlic, chiles, chili powder, oregano, and allspice; sauté for 2 minutes. Stir in beans, chicken stock, carrots, brown sugar, and vinegar. Close cover securely. Place pressure regulator on vent pipe and cook 12 minutes with pressure regulator rocking slowly. Let pressure drop of its own accord. Remove 1 cup of bean mixture, place in blender, and purée until smooth. Return to cooker and stir in fresh cilantro. Season to taste with salt.

8 servings

Minestrone

- | | |
|--|--|
| 1 pound lean beef, cut into 1-inch cubes | 1½ teaspoons dried basil |
| 5 cups water | 1 teaspoon salt |
| 1 can (14–15 ounces) diced tomatoes | 1 bay leaf |
| ½ cup chopped onion | ¼ teaspoon black pepper |
| 1 cup sliced carrots | •••••••• |
| ¼ cup chopped celery | 1 can (16 ounces) Great Northern beans |
| 1 clove garlic, minced | 1 can (15 ounces) cut green beans, drained |
| 2 tablespoons parsley flakes | 2 ounces fine noodles |

Add beef, water, tomatoes, onion, carrots, celery, garlic, parsley, basil, salt, bay leaf, and pepper to cooker. Close cover securely. Place pressure regulator on vent pipe and cook 10 minutes with pressure regulator rocking slowly. Let pressure drop of its own accord. Add Great Northern beans, green beans, and noodles. Simmer uncovered 10 minutes. Garnish with Parmesan cheese, if desired.

10 servings

Saffron Fish Stew

- | | |
|-----------------------------------|---|
| 1 can (14½ ounces) chicken broth | 1 bay leaf |
| ¼ cup dry white wine | Pinch of saffron threads or ¼ teaspoon turmeric |
| 4 new red potatoes, quartered | •••••••• |
| 3 carrots, cut into ½-inch chunks | 1 pound firm fish (halibut, haddock, cod, pollack) fresh or thawed, cut into 8 pieces |
| 1 medium onion, finely chopped | 1 small red pepper, cut into chunks |
| 2 cloves garlic, minced | 1 cup frozen peas, thawed |
| ¼ cup chopped parsley | |

Add broth, wine, potatoes, carrots, onion, garlic, parsley, bay leaf, and saffron to cooker. Close cover securely. Place pressure regulator on vent pipe and cook 2 minutes with pressure regulator rocking slowly. Cool cooker at once. Add fish, pepper, and peas. Close cover securely. Place pressure regulator on vent pipe and cook 1 minute with pressure regulator rocking slowly. Cool cooker at once. Discard bay leaf.

8 servings

Potato Soup

- | | |
|-------------------------------|--|
| 1 tablespoon vegetable oil | ¼ teaspoon white pepper |
| 1 cup finely chopped onion | ¼ teaspoon dried basil |
| ½ cup finely sliced celery | •••••••• |
| 3 cups chicken broth | 1 can (12 ounces) evaporated skim milk |
| 4 cups peeled, diced potatoes | Salt |

Heat oil in cooker over medium heat. Add onion and celery; sauté until tender. Add broth, potatoes, pepper, and basil to cooker. Close cover securely. Place pressure regulator on vent pipe and cook 5 minutes with pressure regulator rocking slowly. Let pressure drop of its own accord. Remove 2 cups of potato mixture; place in blender or food processor and process until smooth. Return to cooker and stir in evaporated milk. Season to taste with salt.

6 servings

Zesty Homemade Chili

- | | |
|-------------------------------|--|
| 1½ pounds ground beef | 1 teaspoon salt |
| 1 can (8 ounces) tomato sauce | 1 teaspoon ground cumin |
| ½ cup water | ½ teaspoon black pepper |
| 1 cup chopped onion | ½ teaspoon dried oregano |
| ¾ cup chopped green pepper | ¼ teaspoon cayenne pepper |
| 2 cloves garlic, minced | ••••• |
| 1 tablespoon chili powder | 1 can (15 ounces) kidney beans, drained and rinsed |

Brown meat in cooker over medium heat. Add tomato sauce, water, onion, green pepper, garlic, chili powder, salt, cumin, black pepper, oregano, and cayenne pepper. Close cover securely. Place pressure regulator on vent pipe and cook 5 minutes with pressure regulator rocking slowly. Let pressure drop of its own accord. Stir in kidney beans and heat through.

4 servings

Fish and Seafood

Fish and seafood are the basis of some of the healthiest and most nutritious meals you can make. Steaming them in the pressure cooker brings out their finest, fullest flavors. Fish and seafood cook very quickly under pressure, and the cooking time required is directly related to the thickness of the seafood. To prevent overcooking, do not cook fish or seafood that is less than ¾ inch thick. Overcooking tends to toughen seafood.

FOR FISH AND SEAFOOD, DO NOT FILL PRESSURE COOKER OVER ¾ FULL!

**OPERATING THE COOKER WITHOUT COOKING LIQUID OR
ALLOWING THE COOKER TO BOIL DRY WILL DAMAGE THE COOKER.**

Salmon Steaks Moutarde

- | | |
|--|---------------------------------------|
| 4 small salmon or halibut steaks, 1 inch thick | 1 cup dry white wine or chicken broth |
| 4 tablespoons Dijon-style mustard | 1 bay leaf |
| 3-4 sprigs fresh thyme or ½ teaspoon dried thyme | ••••• |
| 1 tablespoon olive or vegetable oil | 2 tablespoons Dijon-style mustard |
| 1 small onion, chopped | 1 tablespoon cornstarch |
| 1 clove garlic, minced | |

Spread each steak with 1 tablespoon mustard. Press 1 thyme sprig into mustard on each steak or sprinkle with dried thyme. Heat oil in cooker over medium heat. Add onion and garlic; sauté until tender. Stir in wine and bay leaf. Place steaks on rack in cooker. Close cover securely. Place pressure regulator on vent pipe and cook 2 minutes with pressure regulator rocking slowly. Cool cooker at once. Carefully remove steaks and rack. Keep steaks warm. Discard bay leaf. Mix 2 tablespoons mustard with cornstarch. Stir into liquid in cooker. Heat until sauce boils and thickens, stirring constantly. Serve sauce with salmon steaks.

4 servings

Marinated Tuna

- | | |
|----------------------------------|--------------------------|
| 1 pound tuna steak, 1 inch thick | 2 cloves garlic, minced |
| ¼ cup lemon juice | 1 teaspoon ground ginger |
| 2 tablespoons olive oil | ½ teaspoon black pepper |
| 1 tablespoon soy sauce | ½ cup water |

Place tuna steaks in a shallow glass dish. Mix lemon juice, oil, soy sauce, garlic, ginger, and pepper in a small bowl; pour over tuna. Marinate for 30 minutes, turning fish once. Remove tuna from marinade and place tuna on rack in cooker. Pour marinade and water into cooker. Place pressure regulator on vent pipe and cook 2 minutes with pressure regulator rocking slowly. Cool cooker at once.

4 servings

“Scampi-Style” Shrimp

- | | |
|---|------------------------------------|
| 1 pound medium, raw shrimp, peeled and deveined | ¼ teaspoon salt |
| 3 tablespoons butter | 1 cup water |
| 2 tablespoons minced green onion | ••••• |
| 6 cloves garlic, minced | 2 tablespoons minced fresh parsley |
| 2 teaspoons lemon juice | ¼ teaspoon grated lemon peel |

Pat shrimp dry with paper towels. Melt butter in cooker over medium heat. Add onion and garlic; sauté until tender. Stir in lemon juice and salt. Cook until bubbly. Pour into metal bowl which will fit loosely in cooker. Stir in shrimp. Cover bowl firmly with aluminum foil. Pour water into cooker. Place bowl on rack in cooker. Close cover securely. Place pressure regulator on vent pipe and cook 3 minutes with pressure regulator rocking slowly. Cool cooker at once. Stir in parsley and lemon peel.

4 servings

Shrimp Jambalaya

- | | |
|---|---|
| <ul style="list-style-type: none"> 1 cup long-grain white rice 1½ cups water 1 cup water •••••• 1 can (14–15 ounces) stewed tomatoes ½ cup chicken broth ½ pound precooked ham, diced ½ cup chopped onion ½ cup chopped celery ½ cup chopped green pepper | <ul style="list-style-type: none"> 2 cloves garlic, minced 1 bay leaf 1 teaspoon dried basil ½ teaspoon dried thyme ½ teaspoon chili powder ¼ teaspoon black pepper ¼ teaspoon salt ¼ teaspoon hot sauce •••••• 1 pound precooked shrimp, peeled and deveined |
|---|---|

Combine rice and 1½ cups water in a metal bowl which will fit loosely in cooker. Cover bowl firmly with aluminum foil. Pour 1 cup water into cooker. Place bowl on rack in cooker. Close cover securely. Place pressure regulator on vent pipe and cook 5 minutes with pressure regulator rocking slowly. Let pressure drop of its own accord.

Open cooker and set rice aside to steam. Remove rack and water. Add tomatoes, broth, ham, onion, celery, green pepper, garlic, bay leaf, basil, thyme, chili powder, black pepper, salt, and hot sauce to cooker; stir well. Close cover securely. Place pressure regulator on vent pipe and cook 3 minutes with pressure regulator rocking slowly. Cool cooker at once.

Stir in shrimp; cook uncovered over medium heat until shrimp is heated through, 2 to 3 minutes. Serve over rice.

6 servings

Seafood Gumbo

- | | |
|--|---|
| <ul style="list-style-type: none"> 1 cup long-grain white rice 1½ cups water 1 cup water •••••• 2½ cups chicken broth 1 pound medium, fresh shrimp, peeled and deveined 1 pound sole fillets, cut into 2-inch pieces 1 can (14–15 ounces) diced tomatoes 1 cup chopped onion ¾ cup chopped green pepper 2 cloves garlic, minced | <ul style="list-style-type: none"> 2 bay leaves 2 tablespoons parsley flakes 1 teaspoon dried basil ½ teaspoon dried thyme ¼ teaspoon ground red pepper ¼ teaspoon salt •••••• ¼ cup cold water 2 tablespoons cornstarch 1 package (10 ounces) frozen sliced okra, thawed |
|--|---|

Combine rice and 1½ cups water in a metal bowl which will fit loosely in cooker. Cover bowl firmly with aluminum foil. Pour 1 cup water into cooker. Place bowl on rack in cooker. Close cover securely. Place pressure regulator on vent pipe and cook 5 minutes with pressure regulator rocking slowly. Let pressure drop of its own accord.

Open cooker and set rice aside to steam. Remove rack and water. Add broth, shrimp, sole, tomatoes, onion, green pepper, garlic, bay leaves, parsley, basil, thyme, red pepper, and salt to cooker. Close cover securely. Place pressure regulator on vent pipe and cook 1 minute with pressure regulator rocking slowly.

Cool cooker at once. Combine water and cornstarch. Stir into hot mixture. Heat until sauce thickens, stirring constantly. Stir in okra. Heat for 3 to 4 minutes. Discard bay leaf. Serve over rice.

9 servings

Seafood Timetable

Pour 1 cup water into cooker. Position rack in cooker. Place seafood on rack in cooker. **Do not fill cooker over ¾ full.** Close cover securely. Place pressure regulator on vent pipe and cook according to chart. Cool cooker at once.

Seafood (Fresh or Thawed)	Cooking Time
Crab legs	0 to 1 minutes
Fish fillets, 1 inch thick	2 minutes
Salmon fillets, 1 inch thick	2 minutes
Scallops, large	1 minutes
Shrimp, medium to large (36 to 42 count)	0 to 1 minutes
Shrimp, jumbo (21 to 25 count)	1 minute
Tuna fillets, 1 inch thick	2 minutes

Poultry

A host of great, light meals can evolve from chicken and other poultry when prepared in the pressure cooker. Try the following recipes and enjoy tasty poultry in a variety of ways, or prepare your own favorite poultry dishes. Although not necessary, you may want to brown poultry before pressure cooking to add a different flavor and provide color to the finished dish. For crispier chicken, place the chicken under the broiler for a few minutes after pressure cooking.

**FOR POULTRY, DO NOT FILL PRESSURE COOKER OVER $\frac{2}{3}$ FULL!
NO PORTION OF THE POULTRY SHOULD EXTEND ABOVE THE $\frac{2}{3}$ FULL MARK. SEE PAGE 8.**

**OPERATING THE COOKER WITHOUT COOKING LIQUID OR
ALLOWING THE COOKER TO BOIL DRY WILL DAMAGE THE COOKER.**

Chicken Breasts Tarragon

1 tablespoon vegetable oil	$\frac{1}{4}$ cup sliced celery
4 boneless, skinless chicken breast halves	$\frac{1}{4}$ cup sliced carrot
$\frac{1}{2}$ cup white wine Worcestershire sauce	1 teaspoon dried tarragon
$\frac{1}{2}$ cup white wine	1 teaspoon salt
$\frac{1}{4}$ cup chopped onion	$\frac{1}{4}$ teaspoon black pepper

Heat oil in cooker over medium heat. Brown chicken evenly on both sides. Add white wine Worcestershire sauce, wine, onion, celery, carrot, tarragon, salt, and pepper to cooker. Close cover securely. Place pressure regulator on vent pipe and cook 4 minutes with pressure regulator rocking slowly. Cool cooker at once. Remove chicken and keep warm. Heat sauce over medium heat until desired thickness.

4 servings

California Chicken

2 tablespoons vegetable oil	$\frac{1}{2}$ cup chicken broth
6 boneless, skinless chicken breast halves	$\frac{1}{4}$ cup chopped fresh parsley
1 teaspoon dried rosemary	•••••
3 cloves garlic, peeled and sliced	$\frac{1}{2}$ lemon, thinly sliced
$\frac{1}{2}$ cup white wine	Salt and pepper

Heat oil in cooker over medium heat. Brown chicken evenly on both sides. Season chicken with rosemary. Cover chicken with garlic. Mix wine, broth, and parsley in a small bowl; pour over chicken. Close cover securely. Place pressure regulator on vent pipe and cook 4 minutes with pressure regulator rocking slowly. Cool cooker at once. Garnish chicken with lemon slices. Season to taste with salt and pepper.

6 servings

Chutney Chicken

6 boneless, skinless chicken breast halves	1 tablespoon packed brown sugar
1 can (14–15 ounces) diced tomatoes	$\frac{1}{4}$ teaspoon allspice
1 can (4 ounces) chopped green chiles	•••••
$\frac{1}{2}$ cup raisins	$\frac{1}{4}$ cup water
$\frac{1}{2}$ cup mango chutney	1 tablespoon cornstarch
1 tablespoon vinegar	

Add chicken, tomatoes, chiles, raisins, chutney, vinegar, brown sugar, and allspice to cooker. Close cover securely. Place pressure regulator on vent pipe and cook 4 minutes with pressure regulator rocking slowly. Let pressure drop of its own accord. Remove chicken and keep warm. Mix water and cornstarch. Stir into sauce. Heat until sauce thickens, stirring constantly.

6 servings

Soy Chicken

4 boneless, skinless chicken breast halves	$\frac{1}{2}$ onion, sliced
$\frac{1}{2}$ cup water	$\frac{1}{2}$ cup sliced celery
$\frac{1}{4}$ cup lite soy sauce	3 tablespoons packed brown sugar
$\frac{1}{2}$ cup sliced mushrooms	

Add chicken, water, soy sauce, mushrooms, onion, celery, and brown sugar to cooker. Close cover securely. Place pressure regulator on vent pipe and cook 4 minutes with pressure regulator rocking slowly. Let pressure drop of its own accord.

4 servings

Sweet 'N Sour Chicken

- | | |
|--|---------------------------------|
| 1 tablespoon vegetable oil | 2 tablespoons soy sauce |
| 1 (3-pound) chicken, cut into serving pieces and skinned | 1 tablespoon ketchup |
| 1 can (8 ounces) pineapple chunks, undrained | ½ teaspoon Worcestershire sauce |
| ½ cup sliced celery | ¼ teaspoon ground ginger |
| 1 green or red pepper, cut into chunks | •••••• |
| ¼ cup packed brown sugar | 2 tablespoons cold water |
| ½ cup vinegar | 2 tablespoons cornstarch |

Heat oil in cooker over medium heat. Brown chicken evenly on all sides. Mix pineapple, celery, pepper, brown sugar, vinegar, soy sauce, ketchup, Worcestershire sauce, and ginger in a medium bowl; pour over chicken. Close cover securely. Place pressure regulator on vent pipe and cook 8 minutes with pressure regulator rocking slowly. Cool cooker at once.

Remove chicken, pineapple, and vegetables to a warm platter. Mix water and cornstarch. Stir into hot liquid. Heat until sauce thickens, stirring constantly. Pour sauce over chicken, pineapple, and vegetables. Serve with steamed rice, if desired; see page 22.

6 servings

Chicken Cacciatore

- | | |
|---|------------------------------------|
| 1 tablespoon olive oil | ½ cup chopped celery |
| 1½ cups sliced onions | 2 tablespoons minced fresh parsley |
| 2 cloves garlic, minced | ½ teaspoon chopped fresh oregano |
| 6 chicken thighs | OR 1 teaspoon dried oregano |
| Salt and pepper | •••••• |
| 1 can (15–16 ounces) diced Italian-style tomatoes | 1 can (6 ounces) tomato paste |
| ½ cup white wine | Salt and pepper |
| ½ cup chopped carrots | |

Heat oil in cooker over medium heat. Add onions and sauté until tender. Add garlic and sauté for 30 seconds. Sprinkle chicken with salt and pepper and place in cooker. Add tomatoes, wine, carrots, celery, parsley, and oregano. Close cover securely. Place pressure regulator on vent pipe and cook 8 minutes with pressure regulator rocking slowly. Cool cooker at once.

Place chicken on warm platter and keep warm. Stir tomato paste into sauce in cooker. Simmer until thickened. Season to taste with salt and pepper. Pour sauce over chicken.

6 servings

Herbed Chicken

- | | |
|-----------------------------------|--------------------------------------|
| 1 tablespoon vegetable oil | 1 teaspoon dried oregano |
| 1 cup chopped onion | 1 teaspoon dried basil |
| 1 tablespoon minced garlic | •••••• |
| 3 pounds chicken thighs, skinned | 1 can (4 ounces) sliced black olives |
| 1 cup chicken broth | 2 tablespoons cold water |
| 1 tablespoon minced fresh parsley | 2 tablespoons flour |
| ½ cup chopped celery leaves | Salt and pepper |

Heat oil in cooker over medium heat. Add onion and garlic; sauté until tender. Remove from cooker. Brown chicken. Add onion, garlic, broth, parsley, celery leaves, oregano, and basil. Close cover securely. Place pressure regulator on vent pipe and cook 8 minutes with pressure regulator rocking slowly. Cool cooker at once.

Remove chicken to a warm dish. Add olives to liquid and heat. Mix water and flour. Stir into hot broth. Heat until sauce thickens, stirring constantly. Pour sauce over chicken. Season to taste with salt and pepper.

6 servings

Bayou Bounty Chicken

- | | |
|---|--|
| 1½ pounds chicken pieces | 2 cloves garlic, minced |
| 1 can (15 ounces) whole tomatoes, undrained, cut up | ½ tablespoon extra-spicy seasoning blend |
| ¾ cup chopped onion | •••••• |
| ⅓ cup chopped green pepper | Hot cooked rice (see page 22) |
| ⅓ cup chopped celery | |

Add chicken, tomatoes, onion, pepper, celery, garlic, and seasoning to cooker. Close cover securely. Place pressure regulator on vent pipe and cook 8 minutes with pressure regulator rocking slowly. Let pressure drop of its own accord. Serve chicken and sauce over hot cooked rice.

3 servings

Turkey Breast

Note: Use this recipe only in a 6-quart or 8-quart pressure cooker.

1 tablespoon vegetable oil	¼ teaspoon salt
1 (3- to 4-pound) turkey breast	1½ cups water
1 teaspoon poultry seasoning	1 onion, chopped
½ teaspoon black pepper	½ cup chopped celery

Heat oil in cooker over medium heat. Brown turkey on all sides. Remove turkey from cooker. Mix poultry seasoning, pepper, and salt in a small bowl. Rub mixture evenly over turkey. Add water, onion, and celery to cooker. Place turkey breast on rack in cooker. Close cover securely. Place pressure regulator on vent pipe and cook 35 minutes with pressure regulator rocking slowly. Let pressure drop of its own accord. Thicken cooking liquid, if desired.

6 to 8 servings

Chicken and Dressing

2½ cups cooked chicken, cut into bite size pieces	¼ cup chopped onion
1 can (10½ ounces) cream of chicken soup	2 cups chicken broth
1½ cups seasoned bread crumbs	1½ cups water
¼ cup chopped celery	

Place chicken in greased metal bowl which will fit loosely in the cooker. Cover chicken with chicken soup. Mix bread crumbs, celery, onion, and broth in a medium bowl. Spread over chicken soup. Cover bowl firmly with aluminum foil. Pour 1½ cups water into cooker. Place bowl on rack in cooker. Close cover securely. Place pressure regulator on vent pipe and cook 5 minutes with pressure regulator rocking slowly. Let pressure drop of its own accord.

6 servings

Poultry Timetable

It is not necessary to brown poultry before pressure cooking, but you may do so if you like. After browning, remove poultry from cooker and pour liquid into cooker. Place poultry on rack in cooker.

DO NOT FILL PRESSURE COOKER OVER ¾ FULL! NO PORTION OF THE POULTRY SHOULD EXTEND ABOVE THE ¾ FULL MARK. SEE PAGE 8.

Poultry	Liquid	Cooking Time
Whole Chicken (2½ to 3 pounds)	1 cup	13 to 15 minutes
Chicken (cut into serving pieces)	1 cup	8 minutes
Chicken Breast (boneless)	1 cup	3 to 4 minutes*
Turkey Breast** (3 to 4 pounds)	1½ cups	35 minutes

* Cool cooker at once; see page 4.

** Note: Cook the turkey breast only in a 6-quart or 8-quart pressure cooker.

Meats

A host of great meals can evolve from meat when prepared in the pressure cooker. Keep the following tips in mind when pressure cooking meat.

- Although not necessary, you may want to brown meat before pressure cooking to add a different flavor and provide color to the finished dish. Browning can be done right in the pressure cooker.
- You may also place meat on the grill or under the broiler after pressure cooking to give it last minute browning.
- Cooking time will vary depending on the size and thickness of the cut, the distribution of fat and bone, and the grade and cut of meat. Because of this variability, the timetable on page 18 should be used as a general guide only.
- When cooking larger pieces of meat, such as roasts, keep in mind that thickness rather than weight is the most important factor in determining cooking time. The cooking times found in the meat timetable are for roasts that are 2 to 3 inches thick. If the roast is thicker than 3 inches, add 5 additional minutes to the cooking time.
- If desired, cooking liquid or sauce can be thickened after pressure cooking by simmering 5 to 10 minutes with the cover removed or by adding a thickening agent. Stir 1 to 2 tablespoons of flour or cornstarch into ¼ cup cold water. Slowly add this mixture to the hot liquid. Stir and heat to boiling. Allow to boil for 1 minute or until desired consistency.
- Cooking meat from a frozen state should be reserved only for emergencies. To cook frozen meats, thaw one half hour or more so that the surface of the meat will sear. Then increase the cooking times given in the recipes. Frozen beef, veal, and lamb should be cooked 25 minutes per pound. Frozen pork should be cooked 30 minutes per pound.

**FOR MEAT, DO NOT FILL PRESSURE COOKER OVER ¾ FULL!
NO PORTION OF THE MEAT SHOULD EXTEND ABOVE THE ¾ FULL MARK. SEE PAGE 8.**

**OPERATING THE COOKER WITHOUT COOKING LIQUID OR
ALLOWING THE COOKER TO BOIL DRY WILL DAMAGE THE COOKER.**

Beef Pot Roast

- | | |
|----------------------------|------------------------|
| 1 tablespoon vegetable oil | Salt and pepper |
| 3 pounds beef pot roast | 1 small onion, chopped |
| 2 cups water | 1 bay leaf |

Heat oil in cooker over medium heat. Brown roast well on all sides. Remove roast from cooker. Pour water into cooker. Place roast on rack in cooker. Season roast with salt, pepper, onion, and bay leaf. Close cover securely. Place pressure regulator on vent pipe and cook 45 minutes with pressure regulator rocking slowly. Let pressure drop of its own accord. Thicken gravy, if desired.

6 servings

Porcupine Meatballs

- | | |
|--------------------------------------|----------------------------|
| 1 pound lean ground beef | ¼ cup sliced celery |
| ⅓ cup uncooked long-grain white rice | ¼ cup chopped green pepper |
| 2 tablespoons tomato paste | 1 cup tomato sauce |
| 1 teaspoon salt | ½ cup water |
| ¼ teaspoon black pepper | 1 tablespoon sugar |
| ½ cup chopped onion | ½ teaspoon dry mustard |

Mix ground beef, rice, tomato paste, salt, and black pepper in a medium bowl. Form into 8 balls. Place meatballs in cooker. Add onion, celery, and green pepper. Mix tomato sauce, water, sugar, and mustard in a small bowl. Pour over meatballs. Close cover securely. Place pressure regulator on vent pipe and cook 12 minutes with pressure regulator rocking slowly. Cool cooker at once.

4 servings

Spaghetti Meat Sauce

- | | |
|-------------------------------------|-------------------------------|
| 1 pound lean ground beef | 1 teaspoon parsley flakes |
| 1 can (14–15 ounces) diced tomatoes | ½ teaspoon dried oregano |
| ½ cup water | ½ teaspoon dried basil |
| 1 cup chopped onion | ¼ teaspoon dried thyme |
| ½ cup chopped celery | ⅛ teaspoon red pepper |
| ½ cup diced green pepper | 3 drops hot pepper sauce |
| 1 clove garlic, minced | ••••• |
| 2 teaspoons sugar | 1 can (6 ounces) tomato paste |
| 1 teaspoon salt | |

Brown beef over medium heat. Stir in tomatoes, water, onion, celery, green pepper, garlic, sugar, salt, parsley, oregano, basil, thyme, red pepper, and hot pepper sauce. Close cover securely. Place pressure regulator on vent pipe and cook 8 minutes with pressure regulator rocking slowly. Cool cooker at once. Stir in tomato paste and simmer, uncovered, to desired thickness. Serve sauce over spaghetti. Sprinkle with Parmesan cheese, if desired.

6 servings

Beef Stew

- | | |
|--|-------------------------|
| 1 pound lean beef, cut into 1-inch cubes | 1 cup diced tomatoes |
| 1 cup water | 1 teaspoon salt |
| 1 large onion, sliced | ¼ teaspoon black pepper |
| ••••• | ••••• |
| 4 small potatoes, quartered | ¼ cup cold water |
| 1 cup frozen green beans | 1 tablespoon flour |
| 1 cup sliced carrots | |

Add beef, water, and onion to cooker. Close cover securely. Place pressure regulator on vent pipe and cook 8 minutes with pressure regulator rocking slowly. Cool cooker at once. Add potatoes, green beans, carrots, tomatoes, salt, and pepper to cooker. Close cover securely. Place pressure regulator on vent pipe and cook 3 minutes with pressure regulator rocking slowly. Cool cooker at once. Mix water and flour; stir into stew. Heat until stew thickens, stirring constantly.

4 servings

Swiss Steak

- | | |
|------------------------------------|----------------------------|
| 2 pounds round steak, 1 inch thick | ½ cup chopped green pepper |
| 1 can (8 ounces) tomato sauce | ½ cup sliced celery |
| ½ cup water | ½ teaspoon salt |
| 1 cup chopped onion | ¼ teaspoon black pepper |

Add steak, tomato sauce, water, onion, green pepper, celery, salt, and pepper to cooker. Close cover securely. Place pressure regulator on vent pipe and cook 18 minutes with pressure regulator rocking slowly. Cool cooker at once. Thicken sauce, if desired.

6 servings

Stuffed Flank Steak

1 tablespoon butter	½ teaspoon salt
½ cup chopped onion	¼ teaspoon dried marjoram
½ cup chopped celery	¼ teaspoon dried thyme
1 clove garlic, minced	⅛ teaspoon black pepper
6 tablespoons beef broth, divided	1 pound flank steak, cut into 2 equal pieces
1 cup bread crumbs	1 cup diced tomatoes

Melt butter in cooker over medium heat. Add onion, celery, and garlic; sauté until tender. Remove vegetables from cooker and place in a small bowl. Add 2 tablespoons of the broth, bread crumbs, salt, marjoram, thyme, and pepper to bowl; stir until mixed. Spread stuffing mixture on one steak; top with remaining steak. Secure with toothpicks or metal skewers.

Place steak in cooker; stir in remaining 4 tablespoons broth and tomatoes. Close cover securely. Place pressure regulator on vent pipe and cook 18 minutes with pressure regulator rocking slowly. Let pressure drop of its own accord.

4 servings

Corned Beef

3 pounds corned beef	2 cups water
1 tablespoon garlic powder	1 bay leaf

Rub garlic powder into all surfaces of corned beef. Pour water into cooker. Place corned beef on rack in cooker. Add bay leaf. Close cover securely. Place pressure regulator on vent pipe and cook 60 minutes with pressure regulator rocking slowly. Let pressure drop of its own accord. **Note:** If seasoning packet is provided with corn beef, use packet and omit bay leaf.

6 servings

Barbecue Spareribs

3 pounds spareribs, cut into serving pieces	¼ cup chopped onion
1 cup water	¼ cup sugar
••••••	1 teaspoon salt
1 cup ketchup	1 teaspoon chili powder
½ cup water	1 teaspoon celery seed
½ cup vinegar	

Add ribs and water to cooker. Close cover securely. Place pressure regulator on vent pipe and cook 5 minutes with pressure regulator rocking slowly. Cool cooker at once. Drain off liquid. Mix ketchup, water, vinegar, onion, sugar, salt, chili powder, and celery seed in bowl; pour over ribs in cooker. Stir to coat ribs. Close cover securely. Place pressure regulator on vent pipe and cook 10 minutes with pressure regulator rocking slowly. Let pressure drop of its own accord. Remove ribs. Simmer sauce, uncovered, to desired thickness.

6 servings

Stuffed Pork Chops

2 tablespoons vegetable oil	1 cup bran flakes, crushed
4 boneless pork chops, 1 inch thick, with deep pocket cut in each	2 tablespoons water
1 cup chopped onion	½ teaspoon dried sage
¾ cup chopped celery	1½ cups water
½ cup corn	••••••
	Salt and pepper

Heat oil in cooker over medium heat. Brown pork chops on both sides. Remove from cooker. Add onion and celery to cooker; sauté until tender. Stir in corn, bran flakes, 2 tablespoons water, and sage; remove from cooker. Stuff pork chops with mixture. Pour 1½ cups water into cooker. Place pork chops on rack in cooker. Close cover securely. Place pressure regulator on vent pipe and cook 16 minutes with pressure regulator rocking slowly. Cool cooker at once. Season to taste with salt and pepper.

4 servings

Pork Roast

1 tablespoon vegetable oil	Salt and pepper
3 pound pork roast	1 onion, sliced
2 cups water	

Heat oil in cooker over medium heat. Brown roast well on all sides. Remove roast from cooker. Pour water into cooker. Place roast on rack in cooker. Season with salt, pepper, and sliced onion. Close cover securely. Place pressure regulator on vent pipe and cook 55 minutes with pressure regulator rocking slowly. Let pressure drop of its own accord.

6 servings

Apricot Barbecue Pork Roast

- 3 pound boneless rolled pork roast
- ½ cup ketchup
- ½ cup teriyaki sauce
- ⅓ cup apricot preserves
- ¼ cup cider vinegar
- ¼ cup packed dark brown sugar

- 1 teaspoon crushed red pepper
- 1 teaspoon dry mustard
- ¼ teaspoon black pepper
- 1 tablespoon vegetable oil
- 1 large onion, sliced
- 2 cups water

Place pork roast in a large plastic bag or glass dish. Mix ketchup, teriyaki sauce, preserves, vinegar, brown sugar, red pepper, mustard, and black pepper in a bowl; pour over pork. Refrigerate overnight. Remove pork and reserve marinade. Heat oil in cooker over medium heat. Brown roast on all sides. Remove roast from cooker. Place cooking rack, half of sliced onion, and water in cooker.

Place roast on rack in cooker and arrange remaining onion slices evenly on top of roast. Close cover securely. Place pressure regulator on vent pipe and cook 60 minutes with pressure regulator rocking slowly. Let pressure drop of its own accord. Add reserved marinade to saucepan and simmer until thickened, stirring occasionally. Serve marinade with sliced pork.

8 servings

Lamb Stew

- 1 pound lamb stew meat, cut into 1-inch cubes
- 1 cup water
- 1 large onion, sliced
- 1 tablespoon Worcestershire sauce
- 1 large clove garlic, minced
-
- 4 small potatoes, quartered

- 1 cup baby-cut carrots
- 1 teaspoon salt
- ¼ teaspoon black pepper
-
- ¼ cup cold water
- 1 tablespoon flour

Place lamb, water, onion, Worcestershire sauce, and garlic in cooker. Close cover securely. Place pressure regulator on vent pipe and cook 6 minutes with pressure regulator rocking slowly. Cool cooker at once. Add potatoes, carrots, salt, and pepper. Close cover securely. Place pressure regulator on vent pipe and cook 3 minutes with pressure regulator rocking slowly. Cool cooker at once. Mix water and flour; stir into stew. Heat until stew thickens, stirring constantly.

4 servings

Meat Timetable

Brown meat well and remove from cooker. Pour liquid into cooker. Place meat on rack in cooker.

DO NOT FILL PRESSURE COOKER OVER ⅔ FULL! NO PORTION OF THE MEAT SHOULD EXTEND ABOVE THE ⅔ FULL MARK. SEE PAGE 8.

Type of Meat and Cut	Liquid	Cooking Time
Beef		
Chuck roast, 3 pounds	2 cups	45 to 50 minutes
Corned beef, 3 pounds	2 cups	60 minutes
Rolled rib roast, 3 pounds	1½ cups	30 to 35 minutes
Round steak, 1 inch thick	1 cup	18 minutes*
Round steak, ½ inch thick	1 cup	10 minutes*
Short ribs	1½ cups	25 minutes
Ham		
Slice, 3 pounds	1½ cups	30 to 35 minutes
Picnic, 3 pounds	1½ cups	30 to 35 minutes
Lamb		
Chops, 1 inch thick	1 cup	12 minutes*
Chops, ½ inch thick	1 cup	5 minutes*
Leg of lamb, 3 pounds	2 cups	35 to 45 minutes

Type of Meat and Cut	Liquid	Cooking Time
Pork		
Chops, 1 inch thick	1 cup	15 minutes*
Chops, ½ inch thick	1 cup	8 minutes*
Butt roast, 3 pounds	2 cups	55 minutes
Fresh picnic roast, 3 pounds	2 cups	55 minutes
Steak, 1 inch thick	1 cup	12 minutes*
Steak, ½ inch thick	1 cup	5 minutes*
Veal		
Chops, 1 inch thick	1 cup	12 minutes*
Chops, ½ inch thick	1 cup	5 minutes*
Roast, 3 pounds	2 cups	45 to 50 minutes
Steak, 1 inch thick	1 cup	10 minutes*

* Cool cooker at once; see page 4.

Vegetables

Pressure cooking is a preferred method for preparing vegetables. Because of the fast cooking time and super-heated steam, vegetables retain most of their natural color, texture, flavor, and nutrients.

A garden variety of fresh or frozen vegetables can be cooked at the same time in the pressure cooker. By using the cooking rack to keep them out of the cooking liquid, each vegetable retains its own distinctive flavor and appearance. Just be sure that all vegetables cooked together require the same cooking time. It is important to accurately time the cooking period, because vegetables cook very quickly in the pressure cooker. If you wish to blend the vegetable flavors, place them in the cooking liquid and omit the rack.

FOR FRESH AND FROZEN VEGETABLES, DO NOT FILL PRESSURE COOKER OVER ⅔ FULL!

**OPERATING THE COOKER WITHOUT COOKING LIQUID OR
ALLOWING THE COOKER TO BOIL DRY WILL DAMAGE THE COOKER.**

Garlic Mashed Potatoes

2 pounds russet potatoes, peeled and diced
4 large cloves garlic
1½ cups chicken broth

•••••
1 tablespoon butter
Salt and pepper

Add potatoes, garlic, and chicken broth to cooker. Close cover securely. Place pressure regulator on vent pipe and cook 5 minutes with pressure regulator rocking slowly. Cool cooker at once. Allow potatoes, garlic, and broth to remain in cooker. Mash potatoes using a potato masher or hand mixer until desired consistency is reached. Add butter. Season to taste with salt and pepper.

6 servings

Cabbage with Apples

8 cups shredded cabbage
1 small onion, thinly sliced
1 small tart apple, peeled, cored, and chopped
½ cup chicken broth

2 tablespoons frozen apple juice concentrate, thawed
•••••
Salt and pepper

Add cabbage, onion, apple, chicken broth, and apple juice to cooker. Close cover securely. Place pressure regulator on vent pipe and cook 4 minutes with pressure regulator rocking slowly. Cool cooker at once. Season to taste with salt and pepper.

6 servings

Glazed Root Vegetables

2 tablespoons butter
2 medium turnips, peeled, cut into eighths
8 ounces baby carrots
2 medium parsnips, peeled, sliced ½ inch thick
1 cup chicken broth
2 tablespoons sugar

2 teaspoons ground ginger
•••••
¼ cup cold water, optional
1 tablespoon cornstarch, optional
Salt and pepper

Melt butter in cooker over medium heat. Add turnips and carrots; sauté for 3 minutes. Add parsnips, chicken broth, sugar, and ginger. Close cover securely. Place pressure regulator on vent pipe and cook 1 minute with pressure regulator rocking slowly. Cool cooker at once. Mix water and cornstarch. Stir into sauce. Heat until sauce thickens, stirring constantly. Season to taste with salt and pepper.

8 servings

Maple Glazed Sweet Potatoes

3 sweet potatoes, peeled, cut into 1 to 1½-inch chunks
¾ cup maple flavored syrup
½ cup water

1 tablespoon melted butter
½ teaspoon salt

Place sweet potatoes in cooker. Mix syrup, water, butter, and salt in a bowl; pour over potatoes. Close cover securely. Place pressure regulator on vent pipe and cook 5 minutes with pressure regulator rocking slowly. Cool cooker at once.

6 servings

Artichokes 'N Sauce

1 cup water
1 tablespoon vegetable oil

3 artichokes

Pour water and oil into cooker. Place artichokes on rack in cooker. Close cover securely. Place pressure regulator on vent pipe and cook 10 minutes with pressure regulator rocking slowly. Cool cooker at once. Serve with your choice of the following sauces.

3 servings

Garlic Sauce: Combine ¼ cup melted butter and 2 cloves minced garlic. Serve warm.

Herb Yogurt: Combine 1 cup plain yogurt, ¼ cup finely chopped carrots, ½ teaspoon dill weed, and ¼ teaspoon salt. Serve chilled.

Italian Sauce: Combine ½ cup mayonnaise and ¼ cup Italian style salad dressing. Serve chilled.

Fresh and Frozen Vegetable Timetables

When using the vegetable timetables below, cook the vegetables the minimum amount of time indicated if you prefer your vegetables crisp. If you prefer your vegetables soft, cook them the maximum amount of time indicated. To prevent overcooking, cool cooker at once after cooking vegetables, except when noted.

If the timetable says to cook 0 minutes, this means to cook food until the pressure regulator begins to rock, then cool cooker at once. Quantity of vegetables does not change pressure cooking times. More mature vegetables may require longer pressure cooking times than given in chart.

For fresh and frozen vegetables, pour the liquid into the cooker. Place the vegetables on the rack in the cooker.

FOR FRESH AND FROZEN VEGETABLES, DO NOT FILL PRESSURE COOKER OVER ¾ FULL!

Fresh Vegetable Timetable

Vegetable	Liquid	Cooking Time
Artichoke, whole, 6 to 8 ounces	1 cup	10 minutes
Asparagus, stems, cut into 1-inch pieces	1 cup	0 to 1 minutes
Beans, green or wax, whole or sliced	1 cup	1 to 3 minutes
Beets, whole, 2½-inch diameter	1½ cups	15 to 16 minutes
Broccoli florets	1 cup	0 to 2 minutes
Brussels Sprouts, small, 1-inch diameter	1 cup	1 to 3 minutes
Cabbage, red or green		
Wedges, 2 inch thick	1 cup	3 to 5 minutes
Thinly sliced	1 cup	2 to 3 minutes
Cauliflower florets	1 cup	0 to 2 minutes
Carrots, baby cut or ½-inch slices	1 cup	3 to 5 minutes
<i>Collards (Do not use the rack; place in the cooking liquid.)</i>		
Leaves coarsely chopped	1 cup	3 to 4 minutes
Stems thinly sliced	1 cup	3 to 4 minutes
Corn-on-the-cob, whole, 2½-inch diameter	1 cup	3 minutes
Eggplant		
Cubed, 1 to 1½ inches thick	1 cup	2 to 3 minutes
Sliced, ½ inch thick	1 cup	2 minutes
Kale		
Leaves coarsely chopped	1 cup	1 to 2 minutes
Stems thinly sliced	1 cup	1 to 2 minutes
Parsnips, sliced, ½ inch thick	1 cup	0 to 2 minutes
Peas, shelled	1 cup	0 to 2 minutes
Peppers, whole	1 cup	0 to 3 minutes
Potatoes, sweet		
Sliced, 1 to 1½ inches thick	1 cup	6 to 8 minutes
Sliced, ½ inch thick	1 cup	4 to 5 minutes
Potatoes, white		
Whole, 2½-inch diameter	1½ cups	15 minutes
Whole, 1½-inch diameter	1 cup	10 minutes
Sliced, ¾ inch thick	1 cup	5 minutes
Sliced, ½ inch thick	1 cup	3 minutes
Rutabaga, cubed or sliced, 1 inch thick	1 cup	3 minutes
Spinach, whole leaves	1 cup	0 minutes
<i>Squash, winter (Let pressure drop of its own accord.)</i>		
Acorn, quartered	1 cup	12 minutes
Spaghetti, halved	1 cup	12 minutes
Squash, yellow or zucchini		
Sliced, 1 inch thick	1 cup	1 minute
Sliced, ¼ to ½ inch thick	1 cup	0 to 1 minute
Swiss Chard, whole leaves	1 cup	0 to 1 minute
Turnips, sliced or cubed, ¾ inch thick	1 cup	3 to 5 minutes

Frozen Vegetable Timetable

Vegetable	Liquid	Cooking Time
Asparagus, cut or in spears	1 cup	2 minutes
Beans, green	1 cup	1 to 2 minutes
Beans wax,	1 cup	1 to 2 minutes
Beans, french style	1 cup	1 to 2 minutes
Broccoli	1 cup	1 to 2 minutes
Brussels Sprouts	1 cup	2 to 3 minutes
Cauliflower	1 cup	1 to 2 minutes
Corn Cut	1 cup	1 to 2 minutes
Corn-on-the-cob	1 cup	2 to 3 minutes
Lima Beans	1 cup	1 to 2 minutes
Mixed Vegetables	1 cup	1 to 2 minutes
Peas	1 cup	1 to 2 minutes
Peas and Carrots	1 cup	1 to 2 minutes
Spinach	1 cup	2 to 4 minutes

Dry Beans, Peas, and Lentils

The pressure cooker is ideal for preparing dry beans, peas, and lentils quickly. However, these foods have a tendency to froth and foam during cooking, which could cause the vent pipe to become blocked. Therefore, it is necessary to follow these procedures:

Soaking

Soaking before pressure cooking is strongly recommended for dry beans and peas. Lentils and black-eyed peas do not require soaking. Benefits of soaking include eliminating some of the water soluble starches that produce gas and create froth and foam during cooking, decreasing the cooking time, and producing beans and peas that are more evenly cooked. Soaking can be done using the traditional or the quick method. After soaking, rinse and remove any loose skins.

Traditional method: Clean and rinse the beans and peas, and then cover with three times as much water as beans or peas. Soak 4 to 8 hours. Drain.

Quick method: Clean and rinse the beans and peas, and then cover with three times as much water as beans or peas. Bring the beans or peas to a boil and boil them for 2 minutes. Remove them from heat, cover, and let stand for 1 to 2 hours. Drain.

Cooking

Place beans, peas, or lentils in cooker. Cover with fresh water and **add 1 tablespoon vegetable oil** to help minimize the amount of froth and foam during cooking. **The pressure cooker should never be more than ½ full with beans, peas, lentils, water, and other ingredients.** Close cover securely. Place pressure regulator on vent pipe and cook according to the times in the table below.

For more firm beans for salads and side dishes, use the shorter time. When cooking less than 2 cups of beans or peas, use the longer cooking time. For soups and stews, also use the longer time. **After cooking is complete, allow pressure to drop of its own accord.**

FOR DRY BEANS, PEAS, AND LENTILS, DO NOT FILL PRESSURE COOKER OVER ½ FULL!

**OPERATING THE COOKER WITHOUT COOKING LIQUID OR
ALLOWING THE COOKER TO BOIL DRY WILL DAMAGE THE COOKER.**

Dry Beans, Peas, and Lentils Timetable

Soak beans and peas according to information above. Lentils and black-eyed peas do not require soaking. Add 1 tablespoon vegetable oil to cooking liquid. **Do not cook split peas.**

Beans, Peas, and Lentils	Cooking Time	Beans, Peas, and Lentils	Cooking Time	Beans, Peas, and Lentils	Cooking Time
Adzuki	1 to 3 minutes	Great Northern beans	2 to 5 minutes	Navy beans (pea)	1 to 3 minutes
Anasazi	1 to 3 minutes	Kidney beans	1 to 3 minutes	Peas (whole yellow, green)	6 to 9 minutes
Black beans	2 to 4 minutes	Lentils (brown, green)	3 to 5 minutes*	Pinto beans	3 to 6 minutes
Black-eyed peas	2 to 4 minutes*	Lima beans (large)+	0 to 1 minutes	Red beans	3 to 6 minutes
Chickpeas (garbanzo)+	7 to 10 minutes	Lima beans (baby)+	1 to 3 minutes	Soy beans (beige)	8 to 11 minutes

* Cooking time is for unsoaked beans.

+ Add ½ to 1 teaspoon salt to soaking and cooking water to keep bean skins intact.

Lentil Curry

1 tablespoon vegetable oil
¾ cup chopped onion
3 cups water
1 cup lentils

½ tablespoon ground coriander
½ tablespoon curry powder
½ teaspoon ground ginger
½ teaspoon salt

Heat oil in cooker over medium heat. Add onion and sauté until tender. Add water, lentils, coriander, curry powder, ginger, and salt. Close cover securely. Place pressure regulator on vent pipe and cook 3 minutes with pressure regulator rocking slowly. Let pressure drop of its own accord.

4 servings

Baked Beans

2 cups navy beans
3 cups water
¼ cup ketchup
¼ cup molasses
1 8-ounce slice uncooked ham, diced
1 medium onion, minced

½ cup packed brown sugar
½ teaspoon dry mustard
¼ teaspoon black pepper
•••••
Salt

Soak beans according to instructions above. Add drained navy beans, water, ketchup, molasses, ham, onion, brown sugar, dry mustard, and pepper to cooker. Close cover securely. Place pressure regulator on vent pipe and cook 35 minutes with pressure regulator rocking slowly. Let pressure drop of its own accord. Season to taste with salt.

6 servings

Savory White Beans

2 cups navy beans
3 cups chicken broth
1 cup chopped onion
1 cup sliced carrots
1 tablespoon minced garlic
1 tablespoon vegetable oil

1 small bay leaf
½ teaspoon dried thyme
¼ teaspoon dried rosemary
¼ teaspoon black pepper
•••••
Salt

Soak beans according to instructions on page 21. Add drained navy beans, broth, onion, carrots, garlic, oil, bay leaf, thyme, rosemary, and pepper to cooker. Close cover securely. Place pressure regulator on vent pipe and cook 2 minutes with pressure regulator rocking slowly. Let pressure drop of its own accord. Season to taste with salt.

7 servings

Grains

Grains are an important, but often little recognized, part of a healthy diet. They contribute complex carbohydrates, soluble and insoluble fiber, and other nutrients. Yet with all these benefits, grains are low in fat. Grains can be prepared quickly and conveniently with the pressure cooker without the need to soak or simmer them for several hours.

During cooking many grains tend to froth, foam, and sputter and could cause the vent pipe to become blocked. Therefore, to contain frothing and foaming during the cooking period, grains must be prepared in a bowl covered with aluminum foil in the pressure cooker.

Preparing grains in a bowl also minimizes cleanup which can be difficult if the grains stick to the bottom of the cooker. The bowl can be metal, such as stainless steel, or oven-safe glass. If using glass, increase cooking time by 1 to 5 minutes depending on the length of the recommended cooking time.

**FOR GRAINS, DO NOT FILL PRESSURE COOKER OVER ½ FULL!
OPERATING THE COOKER WITHOUT COOKING LIQUID OR
ALLOWING THE COOKER TO BOIL DRY WILL DAMAGE THE COOKER.**

Grain Timetable

Combine the desired grain and the amount of water or broth indicated in the table below in a bowl which fits loosely in the pressure cooker. Cover bowl securely with aluminum foil. Pour two cups water into cooker. Place bowl on rack in cooker. Close cover securely. Place pressure regulator on vent pipe and cook for the time indicated in the table below.

After pressure cooking, allow pressure to drop of its own accord. Using tongs or hot pads, carefully remove bowl from cooker. Remove foil. Before serving, separate the grains by lifting gently with a fork while steaming. It may be necessary to allow excess moisture to evaporate from some grains. If excessive moisture remains, drain before using grains.

Grain (1 cup)	Liquid in Bowl	Cooking Time	Grain (1 cup)	Liquid in Bowl	Cooking Time
Amaranth	1¼ cups	4 to 5 minutes	Quinoa	1½ cups	1 minute
Barley (hulled)	2½ cups	25 to 28 minutes	Rice (brown)	1 ½ cups	10 to 12 minutes
Barley (pearl)	2½ cups	9 to 12 minutes	Rice (white)	1½ cups	5 to 8 minutes
Buckwheat	2 cups	3 to 4 minutes	Rye Berries	1½ cups	20 to 25 minutes
Bulgar	1½ cups	2 to 3 minutes	Spelt	2 cups	25 to 30 minutes
Millet	2 cups	9 to 10 minutes	Wheat berries	2 cups	25 to 30 minutes
Oats (whole groats)	1½ cups	20 to 25 minutes	Wild Rice	1½ cups	20 to 25 minutes
Oats (steel cut)	2 cups	4 to 5 minutes			

Lemon Rice

1 cup long-grain rice
1½ cups chicken broth
2 teaspoons lemon juice
¼ teaspoon salt

2 cups water
•••••
¼ teaspoon grated lemon peel

Add rice, chicken broth, lemon juice, and salt to a metal bowl which will fit loosely in cooker. Cover bowl firmly with aluminum foil. Pour 2 cups water into cooker. Place bowl on rack in cooker. Close cover securely. Place pressure regulator on vent pipe and cook 5 minutes with pressure regulator rocking slowly. Let pressure drop of its own accord. Open cooker, remove foil, and set rice aside to steam for 5 minutes. Stir in lemon peel.

4 servings

Seasoned Rice Pilaf

2 tablespoons butter	½ teaspoon salt
1 small onion, chopped	½ teaspoon dried oregano
2 cups long-grain white rice	¼ teaspoon black pepper
2 cups chicken broth	2 cups water
1¾ cups water	

Melt butter in cooker over medium heat. Add onion and sauté until tender. Remove onion and add to a metal bowl which will fit loosely in cooker. Add rice, broth, 1¾ cup water, salt, oregano, and pepper to metal bowl. Cover bowl firmly with aluminum foil. Pour 2 cups water into cooker. Place bowl on rack in cooker. Close cover securely. Place pressure regulator on vent pipe and cook 5 minutes with pressure regulator rocking slowly. Let pressure drop of its own accord. Open cooker, remove foil, and set rice aside to steam.

8 servings

Variation: Grecian Rice Pilaf

After pressure has dropped of its own accord, combine rice, ¾ cup peas, ½ cup sliced ripe olives, and 1 red pepper, finely chopped. Allow rice to steam uncovered 5 minutes.

Wild Rice with Raisins and Pecans

1 tablespoon vegetable oil	2 cups water
1 medium onion, finely chopped	••••••
1½ cups wild rice	¾ cup golden raisins
2 cups beef broth	⅓ cup pecans, toasted

Heat oil in cooker over medium heat. Add onion and sauté until tender. Remove onion and add to a metal bowl which will fit loosely in cooker. Add rice and broth to metal bowl. Cover bowl firmly with aluminum foil. Pour water into cooker. Place bowl on rack in cooker. Close cover securely. Place pressure regulator on vent pipe and cook 25 minutes with pressure regulator rocking slowly.

Let pressure drop of its own accord. Open cooker and remove aluminum foil; add raisins and allow to steam for 5 minutes. Remove bowl from cooker; stir in pecans.

8 servings

Risotto with Artichoke hearts and Sun-dried Tomatoes

1 tablespoon olive oil	••••••
1 cup arborio rice	1 can (13¾ ounces) artichoke hearts, drained and coarsely chopped
2 cloves garlic, minced	¼ cup grated Parmesan cheese
2 cups chicken broth	1½ tablespoons fresh thyme or 1½ teaspoons dried thyme
⅓ cup white wine	Salt and pepper
⅓ cup dried tomatoes, chopped	
2 cups water	

Heat oil in cooker over medium heat. Add rice and stir for 2 minutes until coated and slightly translucent. Add garlic and cook for 1 minute. Remove rice and garlic and add to a metal bowl which will fit loosely in cooker. Add broth, wine, and tomatoes to metal bowl. Cover bowl firmly with aluminum foil. Pour water into cooker. Place bowl on rack in cooker. Close cover securely.

Place pressure regulator on vent pipe and cook 8 minutes with pressure regulator rocking slowly. Let pressure drop of its own accord. Open cooker and remove foil. Stir artichoke hearts, Parmesan cheese, and thyme into rice. Season to taste with salt and pepper.

4 servings

Desserts

Desserts may be prepared in oven-safe custard cups or any metal mold which will fit loosely in the pressure cooker. Fill molds only ⅔ full to allow for expansion of food. Cover securely with aluminum foil shaped to the sides of the mold. Place the mold or custard cups on the cooking rack in the cooker. Refer to the chart below for the number of custard cups your cooker will hold and how the custard cups should be positioned on the cooking rack. **Do not cook applesauce, cranberries, or rhubarb in the pressure cooker.**

Pressure Cooker (Stock Number)	Quantity	Positioning Instructions
4 quart Aluminum (01241)	4 custard cups	Place two custard cups on cooking rack. Then, stack the other two custard cups opposite the bottom two custard cups.
4 quart Stainless (01341)	3 custard cups	Place three custard cups on cooking rack.
6 quart Aluminum (01264) and 6 quart Stainless (01362)	6 custard cups	Place three custard cups on cooking rack. Then, stack the other three custard cups opposite the bottom three custard cups.
8 quart Aluminum (01282)	8 custard cups	Place four custard cups on cooking rack. Then, stack the other four custard cups opposite the bottom four custard cups.

FOR DESSERTS, DO NOT FILL PRESSURE COOKER OVER ⅔ FULL!
OPERATING THE COOKER WITHOUT COOKING LIQUID OR
ALLOWING THE COOKER TO BOIL DRY WILL DAMAGE THE COOKER.

Stuffed Apples

- | | |
|-------------------------------|----------------------------|
| ¼ cup golden raisins | ½ teaspoon ground cinnamon |
| ½ cup dry red wine | 4 cooking apples |
| ¼ cup chopped nuts | 1 tablespoon butter |
| 2 tablespoons sugar | 1 cup water |
| ½ teaspoon grated orange rind | |

Soak raisins in wine for at least 30 minutes. Drain, reserving wine. Mix raisins, nuts, sugar, orange rind, and cinnamon in a small bowl. Core apples, cutting to but not through bottoms. Peel top one-third of apples. Place each apple on square of aluminum foil that is large enough to completely wrap apple. Fill centers with raisin mixture. Top each with one-fourth of the butter.

Wrap foil around apple, pinching firmly together at top. Place reserved wine, water, and apples in cooker. Close cover securely. Place pressure regulator on vent pipe and cook 10 minutes with pressure regulator rocking slowly. Cool cooker at once.

4 servings

Rice Pudding

- | | |
|-----------------------------|----------------------------|
| 1 cup long-grain white rice | 1 cup whole milk |
| 1½ cups water | ½ cup sugar |
| 1 cup water | ½ cup raisins |
| •••••• | ½ teaspoon ground cinnamon |

Combine rice and 1½ cups water in a metal bowl which will fit loosely in cooker. Cover bowl firmly with aluminum foil. Pour 1 cup water into cooker. Place bowl on rack in cooker. Close cover securely. Place pressure regulator on vent pipe and cook 10 minutes with pressure regulator rocking slowly. Cool cooker at once.

Stir milk, sugar, raisins, and cinnamon into rice. Cover bowl firmly with aluminum foil. Place bowl on rack in cooker. Close cover securely. Place pressure regulator on vent pipe and cook 3 minutes with pressure regulator rocking slowly. Let pressure drop of its own accord.

6 servings

Vanilla Custard

- | | |
|-------------------------|--------------------|
| 2 cups low-fat milk | ½ teaspoon vanilla |
| 2 eggs, slightly beaten | Ground nutmeg |
| ¼ cup sugar | 1 cup water |
| ¼ teaspoon salt | |

Mix milk, eggs, sugar, salt, and vanilla in a bowl; pour into individual custard cups. Sprinkle nutmeg on custards. Cover each cup firmly with aluminum foil. Pour water into cooker. Place custard cups on rack in cooker. Close cover securely. Place pressure regulator on vent pipe and cook 5 minutes with pressure regulator rocking slowly. Cool cooker at once. Chill.

4 servings

Petite Pumpkin Custards

- | | |
|--|--------------------------|
| 1 can (16 ounces) solid-pack pumpkin | ¼ teaspoon ground cloves |
| 1 can (14 ounces) sweetened condensed milk | 1 cup water |
| 3 eggs, beaten | •••••• |
| 1 teaspoon ground cinnamon | Whipped cream, optional |
| 1 teaspoon finely chopped candied ginger, optional | |

Mix pumpkin, milk, eggs, cinnamon, ginger, and cloves in a bowl; pour into individual custard cups. Cover each cup firmly with aluminum foil. Pour water into cooker. Place custard cups on rack in cooker. Close cover securely. Place pressure regulator on vent pipe and cook 10 minutes with pressure regulator rocking slowly. Cool cooker at once. Refrigerate until chilled. Serve with whipped cream, if desired.

8 servings

Oatmeal Apple Crisp

4 cups apples, peeled and sliced
1 tablespoon lemon juice
½ cup quick cooking oats
¼ cup packed brown sugar

2 tablespoons flour
1 teaspoon ground cinnamon
2 tablespoons butter, softened
2 cups water

Grease a 1-quart bowl which will fit loosely in cooker. Sprinkle apples with lemon juice. Mix oats, brown sugar, flour, and cinnamon in a bowl. Add butter. Using a pastry blender or fingers, work butter into mixture until it resembles coarse crumbs. Place apples in prepared bowl. Sprinkle oat mixture evenly over apples. Cover bowl firmly with aluminum foil.

Pour water into cooker. Place bowl on rack in cooker. Close cover securely. Place pressure regulator on vent pipe and cook 20 minutes with pressure regulator rocking slowly. Cool cooker at once.

4 servings

Cheesecake

1 8-ounce package cream cheese
1 3-ounce package cream cheese
½ cup sugar

2 eggs
½ cup vanilla wafer crumbs
2½ cups water

Coat 6 custard cups with no-stick cooking spray. Beat cream cheese until smooth in a medium bowl. Add sugar and beat in eggs. Pour mixture into prepared custard cups. Top with vanilla wafer crumbs. Cover each cup firmly with aluminum foil. Pour water into cooker. Place custard cups on rack in cooker.

Close cover securely. Place pressure regulator on vent pipe and cook 15 minutes with pressure regulator rocking slowly. Cool cooker at once. Cool cheesecake. Cut around inside of cups to loosen and invert onto serving dish. Chill. Top with one of the following sauces, if desired.

6 servings

Caramel Sauce

Combine ¼ cup soft cream cheese, ¼ cup packed brown sugar, 1 tablespoon granulated sugar, and ¼ teaspoon vanilla. Mix thoroughly. Spoon over cheesecake. Garnish with pecans. Refrigerate until serving.

Fruit Sauce

Spoon canned fruit pie filling of your choice over cheesecake. Refrigerate until serving.

Recipe Index

Desserts	23	Meats	15
Cheesecake	25	Apricot Barbecue Pork Roast	18
Oatmeal Apple Crisp	25	Barbecue Spareribs	17
Petite Pumpkin Custards	24	Beef Pot Roast	16
Rice Pudding	24	Beef Stew	16
Stuffed Apples	24	Corned Beef	17
Vanilla Custard	24	Lamb Stew	18
Dry Beans, Peas, And Lentils	21	Meat Timetable	18
Baked Beans	21	Porcupine Meatballs	16
Dry Beans, Peas, and Lentils Timetable	21	Pork Roast	17
Lentil Curry	21	Spaghetti Meat Sauce	16
Savory White Beans	22	Stuffed Flank Steak	17
Fish and Seafood	11	Stuffed Pork Chops	17
Marinated Tuna	11	Swiss Steak	16
Salmon Steaks Moutarde	11	Poultry	13
“Scampi-Style” Shrimp	11	Bayou Bounty Chicken	14
Seafood Gumbo	12	California Chicken	13
Seafood Timetable	12	Chicken Breasts Tarragon	13
Shrimp Jambalaya	12	Chicken Cacciatore	14
Grains	22	Chicken and Dressing	15
Grain Timetable	22	Chutney Chicken	13
Grecian Rice Pilaf	23	Herbed Chicken	14
Lemon Rice	22	Poultry Timetable	15
Risotto with Artichoke Hearts and Sun-Dried Tomatoes	23	Soy Chicken	13
Seasoned Rice Pilaf	23	Sweet ’N Sour Chicken	14
Wild Rice with Raisins and Pecans	23	Turkey Breast	15

Recipe Index continued

Soups and Stocks	9	Potato Soup	10
Beef Tomato Soup	9	Saffron Fish Stew	10
Black Bean Soup	10	Zesty Homemade Chili	11
Brown Beef Soup	9	Vegetables	19
Brown Beef Soup Stock	9	Artichokes 'N Sauce	19
Chicken Dumpling Soup	9	Cabbage with Apples	19
Chicken Noodle Soup	9	Fresh Vegetable Timetable	20
Chicken Rice Soup	9	Frozen Vegetable Timetable	20
Chicken Soup	9	Garlic Mashed Potatoes	19
Chicken Soup Stock	9	Glazed Root Vegetables	19
Minestrone	10	Maple Glazed Sweet Potatoes	19
Onion Soup	9		

Consumer Service Information

If you have any questions regarding the operation of your Presto® cooker or need parts for your cooker, contact us by any of these methods:

- Call 1-800-877-0441 weekdays 8:00 AM to 4:00 PM (Central Time)
- Email us through our website at www.GoPresto.com/contact
- Write to National Presto Industries, Inc., Consumer Service Department, 3925 N. Hastings Way, Eau Claire, WI 54703-3703

Inquiries will be answered promptly by telephone, email, or letter. When emailing or writing, please include a phone number and a time when you can be reached during weekdays, if possible. When contacting the Consumer Service Department or when ordering replacement parts, please indicate the model and series numbers found stamped on the side of the cooker body.

Please record this information:

Model _____ Series _____ Date Purchased _____

Any maintenance required for this cooker, other than that described in the “Cleaning” and “Care and Maintenance” sections of this book (pages 6 and 7), should be performed by our Factory Service Department. **Note:** We do recommend that you call our Consumer Service Department at 1-800-877-0441 prior to sending your cooker in for repair. Be sure to indicate date of purchase and a description of the problem when sending a cooker for repair. Send cookers for repair to:

Canton Sales and Storage Company, Presto Factory Service Department, Attn: Repair
555 Matthews Drive Canton, MS 39046-3251

The Presto Factory Service Department is equipped to service all Presto® appliances and supply genuine Presto® parts. Genuine Presto® replacement parts are manufactured to the same exacting quality standards as Presto® appliances and are engineered specifically to function properly with its appliances.

Presto can only guarantee the quality and performance of genuine Presto® parts. “Look-alikes” might not be of the same quality or function in the same manner. To ensure that you are buying genuine Presto® replacement parts, look for the Presto® trademark.

Replacement parts are available at hardware stores and other retail outlets. Parts may also be ordered online at www.GoPresto.com.

Get the most from your Presto® Pressure Cooker with these handy accessories...

Stainless Steel Steamer Basket and Trivet (Part 85650)

The handiest way to cook several foods at the same time in your Presto® Pressure Cooker. The trivet lifts the basket off the bottom of the cooker so there is no intermingling of flavors. The basket is made of stainless steel for lasting beauty and durability. Fits Presto® Pressure Cookers with an inside diameter greater than 8 inches.



Colander Cover (Part 09986)

Draining liquids off most any solid food is easy and convenient with this special perforated cover. It twists onto the lugs of the Presto® Pressure Cooker body so it stays securely in place while pouring. Fits all current model 4- and 6-quart Presto® Pressure Cookers except stock no. 02141.



How to Order

Visit www.GoPresto.com or call 1-800-877-0441 weekdays between 8:00 AM and 4:00 PM (Central Time). Please have your credit card number and expiration date ready. Payment options are limited to credit card only.

Product Registration

Important: Please go online and register this product within ten days of purchase. Proper registration will serve as proof of purchase in the event your original receipt becomes misplaced or lost. Registration will not affect warranty coverage, but it may expedite the processing of warranty claims.

The additional information requested will help us develop new products that best meet your needs and desires. To register the product, visit www.GoPresto.com/registration or simply scan this QR code. If you do not have computer access, contact the Consumer Service Department at 1-800-877-0441.



Presto® Limited Warranty (Applies only in the United States)

This quality Presto® appliance is designed and built to provide many years of satisfactory performance under normal household use. Presto pledges to the original owner that should there be any defects in material or workmanship during the first twelve (12) years after purchase, we will repair or replace it at our option.

Our pledge does not apply to normal wear and tear including scratches, dulling of the polish, or staining; the repair or replacement of moving and/or perishable parts such as the sealing ring, overpressure plug, or air vent/cover lock gasket; or for any damage caused by shipping. ***Outside the United States, this limited warranty does not apply.***

To obtain service under the warranty, please call our Consumer Service Department at 1-800-877-0441. If unable to resolve the problem, you will be instructed to send your Presto® appliance to the Presto Factory Service Department for a quality inspection; shipping costs will be your responsibility. When returning an appliance, please include your name, address, phone number, and the date you purchased the appliance, as well as a description of the problem you are encountering with the appliance.

We want you to obtain maximum enjoyment from using this Presto® appliance and ask that you read and follow the instructions enclosed. Failure to follow instructions, damage caused by improper replacement parts, abuse, misuse (including overheating and boiling the unit dry), disassembly, alterations, or neglect will void this pledge.

This warranty gives you specific legal rights, and you may also have other rights which vary from state to state. This is Presto's personal pledge to you and is being made in place of all other express or implied warranties.